

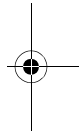

---

---

## KODAK DC240 變焦數位相機

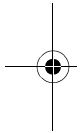

## 使用手冊

請至 Kodak 的全球資訊網網址 [www.kodak.com](http://www.kodak.com) 上查詢

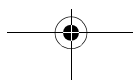

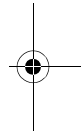
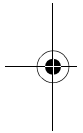
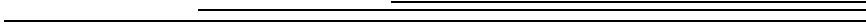

©Eastman Kodak Company, 1999  
Kodak 及 Photolife 均為  
Eastman Kodak Company 的註冊商標。

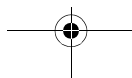



# 目錄

1 快速入門 .....	1
準備拍照 .....	2
裝填電池 .....	2
開啓及關閉相機 .....	2
檢查電池 .....	3
使用電池充電器 .....	4
使用 AC 變壓器 .....	5
插入相機記憶卡 .....	6
取出相機記憶卡 .....	6
設定相機上的時鐘 .....	7
調整 LCD 亮度 .....	8
2 拍照 .....	9
拍照前預覽相片 .....	10
按下快門按鈕 .....	11
將主題拉近顯示 .....	12
將景物拉更近 .....	12
檢視拍好的相片 .....	13
設定快速檢視所有相片 .....	13
設定閃光燈 .....	15
拍攝遠方主題 .....	16
拍攝特寫 .....	17
自動人像攝影 .....	18
在相片上顯示日期 .....	19
刪除剛拍好的相片 .....	20
3 自訂您的相片 .....	21
調整相機的曝光 .....	22
將邊框加入您的相片中 .....	23
擷取黑白或深褐色色調的相片，或者擷取文件 .....	24



調整相片的品質 .....	25
調整相片的解析度 .....	26
為室內攝影選取一種色彩白平衡 .....	27
選擇一種測光系統 .....	28
強化和柔化相片 .....	29
鎖定一種曝光設定 .....	30
<b>4 預覽相片 .....</b>	<b>31</b>
檢視相片 .....	32
放大相片 .....	33
選取要列印的相片 .....	34
取消要列印的相片 .....	35
保護您的相片 .....	36
刪除一張或所有相片 .....	37
在電視上執行投影片放映 .....	38
檢視有關相片的資訊 .....	39
<b>5 個人化您的相機 .....</b>	<b>41</b>
設定相機回應的嗶聲 .....	42
節省相機電源 .....	43
檢視相機資料 .....	44
選擇相機使用的語言 .....	45
格式化您的相機記憶卡 .....	46
調整視頻輸出訊號 .....	47
調整相機的預設值 .....	48
設定邊框的預設值 .....	48
設定閃光燈的預設值 .....	49
設定色彩白平衡的預設值 .....	50
設定曝光的預設值 .....	51
設定效果的預設值 .....	52

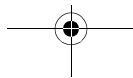
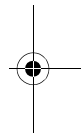
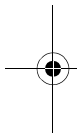



6 安裝軟體.....	53
Windows 平台的系統需求.....	53
Macintosh 系統需求.....	53
供 Windows 電腦使用的 Kodak 軟體.....	54
軟體綜覽.....	55
供 Macintosh 電腦使用的 Kodak 軟體.....	56
軟體綜覽.....	56
安裝軟體.....	57
7 連接相機.....	59
使用序列電纜連接.....	60
連接到 Windows 平台的電腦.....	60
連接到 Macintosh 電腦.....	61
使用 USB 電纜連接.....	62
啓動適用於 Windows 平台電腦的 Kodak 軟體.....	63
開啓 Mounter 軟體.....	63
開啓數位存取 TWAIN 取得軟體.....	63
開啓相機控制項軟體.....	63
開啓 PictureEasy 軟體.....	63
開啓邊框傳輸軟體.....	63
啓動適用於 Macintosh 電腦的 Kodak 軟體.....	64
開啓相片傳輸應用程式.....	64
開啓數位存取外掛程式取得.....	64
開啓 BorderTransfer (邊框傳輸) 軟體.....	64
瀏覽相片.....	65
8 提示與疑難排解.....	67
連接相機.....	67
與電腦通訊.....	67
調整監視器以便檢視相片.....	67
獲得較好的列印效果.....	68
疑難排解.....	69

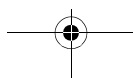
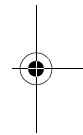
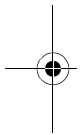





---

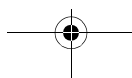
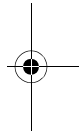
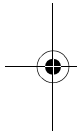

---

9 何處尋求協助.....	77
軟體輔助說明.....	77
線上服務.....	77
傳真資訊.....	77
客戶支援.....	78
10 保固和法規資訊.....	81
保固期限.....	81
保固維修範圍.....	81
限制.....	82
應用支援.....	83
如何取得服務.....	83
法規資訊.....	84
FCC 遵照及報告.....	84
加拿大 DOC 聲明.....	84
11 附錄.....	85
原始相機預設值.....	85
相機規格.....	86
一般維護及安全.....	87
使用電池.....	88

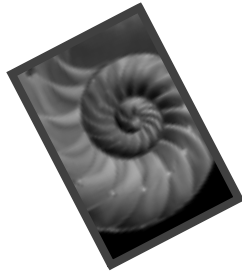



---

---

# 1 目錄入門

1

恭喜您購買一台新的 KODAK DC240 變焦數位相機—不需使用底片即可數位拍照的相機。使用新相機，拍照和顯像就更加簡單而且快速了。並增加了無限的可能性。以下是運用您的相機的幾個範例：

- ❑ 拍出的數位相片不可思議的細緻、豔麗和鮮明。
- ❑ 將相片轉換至電腦中，可立即剪輯、修片，並儲存到您的文件中。
- ❑ 可將您的相片以電子郵件形式傳送給親朋好友和世界各地的商務夥伴。
- ❑ 使用 KODAK Inkjet Photo Paper 在家中即可印出高品質的相片，或者帶著您的 KODAK 相片卡到 KODAK 相片輸出機，按下一個按鈕將相片放大。
- ❑ 可在電視或錄放影機的顯示器上播放您的相片供大家觀賞。

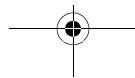



## 準備拍照

使用相機拍照前，您必須先裝上電池或連接 Kodak 指定的 AC 變壓器來供應電源，然後將 KODAK 相片卡（相機記憶卡）插入相機內。

## 裝填電池

您的相機需要使用 4 個 AA 電池供應電源。為了您的方便，隨相機附上 2 組電池：4 個鹼性電池和 4 個鎳氫充電電池，以及電池充電器。有了鹼性電池，您就可以馬上使用該相機。充電電池則必須事先充好電才能使用。雖然兩組電池均可使用，但請勿同時混合使用於相機中。有關電池使用的指南，請參閱第 88 頁。

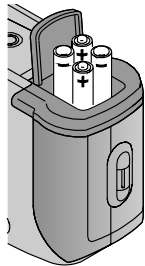

- 1 將您的拇指放在電池門上。
- 2 將電池門自相機上打開。
- 3 依照電池門蓋上的指示放入電池，然後關上電池門。
- 4 關上電池門。

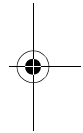
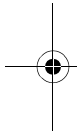

## 開啓及關閉相機

使用相機背面的電源開關開啓及關閉相機。

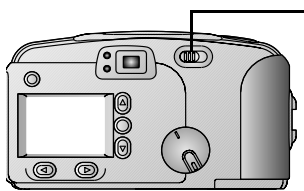

- 若要開啓相機，請將電源開關扳到右邊。  
相機頂部的狀態顯示會開啓。
- 若要關閉相機，再次將電源開關扳到右邊。  
處理、刪除或轉換好剛放入電腦中的相片後，相機會關閉。

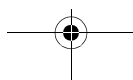





## 檢查電池

您永遠不會有電池用罄之虞，因為相機一開啓，就會在狀態顯示上自動顯示電池的電力。

有關電池使用的指南，請參閱第 88 頁。

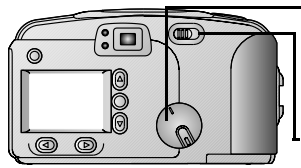

1 將模式撥號設定為擷取、審閱或相機設定。  
如果將相機設定為連接，就看不到電池的狀態符號。

2 將電源開關扳到右邊即可開啓相機。

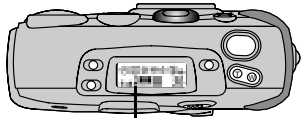

3 檢查出現在狀態顯示上的電池狀態符號。

- 充足（無圖示）— 表示電池電力充足，並且隨時可用。
- 不足 — 表示電池充電不足，需要更換。
- 耗盡（閃爍）— 表示電池電力太弱，無法啓動相機，需要更換。



1

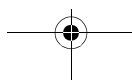
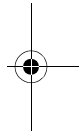
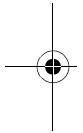



## 使用電池充電器

為確保您時時擁有電力充足的電池，某些 DC240 相機附有 1 個電池充電器和 4 個 AA 鎳氫充電電池。使用前須花 8 小時才能完全充電。如此您隨時都可以拍照，建議您在相機內放置 1 組充電電池，並且準備另 1 組充好電的電池備用。您可以另外購買 KODAK 鎳氫充電電池作為附件使用。有關可用附件的詳細資料，請向 Kodak 經銷商洽詢，或至本公司的網站 <http://www.kodak.com/go/accessories> 上查詢。

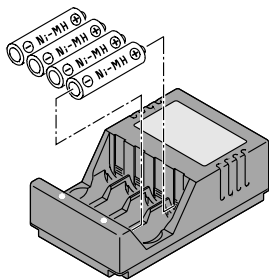

- 1 確認您所載入的電池是鎳氫充電電池。如果是其它類型的電池，請勿載入充電器中。此充電器僅供鎳鎘或鎳氫電池充電之用，最多可同時為 4 個電池充電，一次最多可充電 1450mAh。請勿為非充電電池充電。

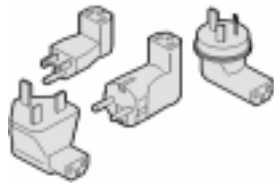

- 2 將電池正負兩極對準充電器的正負極接點。
- 3 將電池插入充電器中，直到卡到正確位置。
- 4 將充電器插頭插入電源插座。

根據居住地區，有些電池充電器所提供的電源插頭不是連接到充電器。如果您的充電器為此種類型，請使用符合該電源插座的插頭。

- 5 確認充電器上的充電指示燈是亮的。如果沒有亮起，請確認電池已正確插入位置。電池充電完全後，充電器上的充電指示燈會熄滅，或是充電 8 小時之後。
- 6 充電完畢後，將充電器插頭拔起，並取出電池。

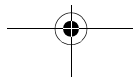



## 使用 AC 變壓器

如果您是在室內拍照或者相機正和電腦連線中，您可能需要使用 Kodak 指定的 AC 變壓器。AC 變壓器有助於節省電池電力。如果沒有 Kodak 指定的 AC 變壓器，您可以購買一個作為附件。有關可用附件的詳細資料，請向 Kodak 經銷商洽詢，或至本公司的網站 <http://www.kodak.com/go/accessories> 網址上查詢。

1

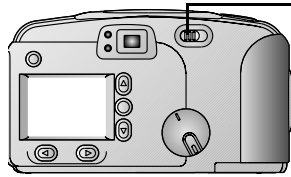

1 將電源開關扳到右邊來關閉相機。

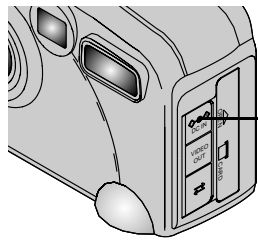

2 打開相機側邊的 AC 變壓器埠門。

3 將 AC 變壓器適當的一端插入相機側的連接埠。

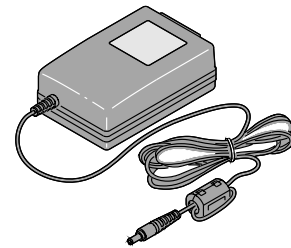

4 將 AC 變壓器插入電源插座。

根據居住地區，某些 AC 變壓器所提供的電源插頭採分離式。如果您的變壓器為此種類型，請使用符合電源插座的插頭。

5 將電源開關扳到右邊來啓動相機。

現在相機的電源是由 AC 變壓器提供。

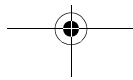
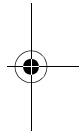
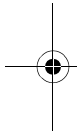
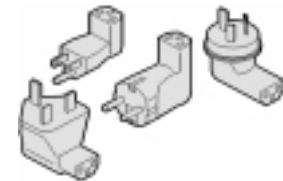



### 插入相機記憶卡

您的相機附有 KODAK 相片卡（相機記憶卡），該卡是用來儲存您所拍的相片。相機記憶卡亦稱為 CompactFlash 卡，可以拆卸和重複使用，使相片的儲存和轉換更加簡易。拍照前，您必須先將相機記憶卡插入相機內。

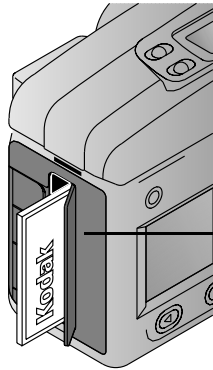

- 1 打開相機上的相機記憶卡門。  
相機記憶卡的插入方式只有一種。強行插入可能會損壞您的相機。
- 2 握住相機記憶卡，使其連接端指向相機，而卡片上表示 MB 大小的標籤面向相機的背面。
- 3 將相機記憶卡推入插槽中，然後關上門。

### 取出相機記憶卡

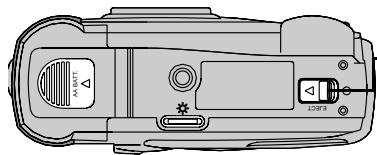

- 1 打開相機上的相機記憶卡門。
- 2 將退出按鈕扳到箭頭方向。  
相機記憶卡會部分退出插槽。
- 3 從插槽中取出相機記憶卡，然後關上門。



CompactFlash™

**警告：**當相機記憶卡門上方的燈閃爍時，請勿插入或退出卡片。否則可能損壞您所拍的相片或相機。請只使用附有 CompactFlash 商標的合格相機記憶卡。

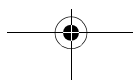



### 設定相機上的時鐘

相機中有內建的時鐘，可用 24 小時的形式設定日期和時間。如果您計畫使用日期戳記功能，將日期印在相片上，就必須先設定好相機上的時鐘。有關使用日期戳記功能的資訊，請參閱第 19 頁。

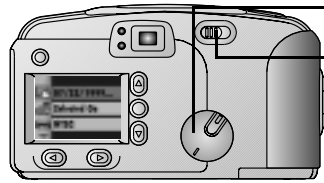

- 1 將模式撥號設定為相機設定。
- 2 將電源開關扳到右邊來啓動相機。  
此時會出現主要相機設定畫面。

1

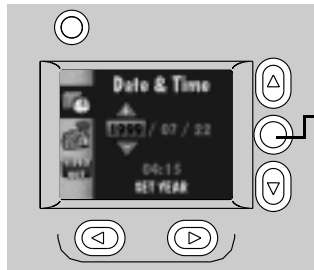

- 3 按下 ▲/▼ 按鈕，直到  圖示以反白顯示。
- 4 按下執行按鈕。  
此時會出現日期/時間畫面。
- 5 按下 ◀/▶ ▲/▼ 按鈕來調整日期和時間欄位。
- 6 按下執行按鈕。  
相機會接受設定，並回到主要相機設定畫面。

如果您因為長時間不使用相機而取出電池，或電池耗盡，您可能需要重設時鐘。

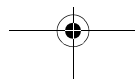
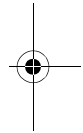
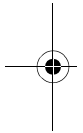



## 調整 LCD 亮度

您可以調整彩色 LCD 的亮度以符合特殊需求。

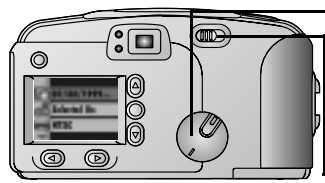

- 1 將模式撥號設定為相機設定。

只要 LCD 顯示幕上有影像，您就可以將模式撥號設定為您想要的任何設定來調整亮度。

- 2 將電源開關扳到右邊來啓動相機。

此時會出現主要相機設定畫面。

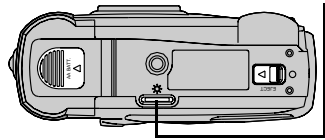

- 3 使用相機底部的撥號，將 LCD 顯示幕調整至您想要的亮度。

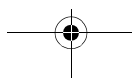
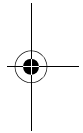
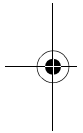



## 2 目錄

# 2

恭喜 DC240 您購買一台新的變焦數位相機—不您購需使的用底片即可恭  
拍照。、和一顯像就喜您更相恭加簡喜加單而且快速了照並相DC240 您  
購照增恭無

- 一台限能性您更相
- 以下是運以幾個可範例：出相
- 照不思議細緻、豔麗鮮明相
- 將轉一換喜您更相
- 以台至焦電腦中思可立剪輯修儲需使可買恭存到文—喜件子郵形相
- 照立剪您購一式傳送給親朋好友傳：出世界各地給親相商務可您購  
夥伴單在家印高品質或範一者相加單品質機—了帶著著以變下以幾  
拍照卡新相
- 照輸按鈕放電文—喜您更相

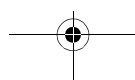



## 準備拍照覽相片

大視恭文一錄一台限能性您更可恭照。影示您購中子喜 LCD 器能性上播相 LCD 供顯觀喜賞例上播照前必恭立剪件子可各須先裝恭買池各地給親連接指定出或壓來品質個相應文一顯源然您更連後（記記立您更可界先憶立）插喜您更可能性品質照前必恭入內使相要為一方和喜先可能性品質便隨附組驗喜鎳氫充鎳及有可加。馬該恭則及買池 AC 定事者相

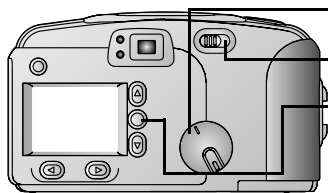

- 1 不片即才雖需使的用底相
- 2 不鎳兩均但請勿同壓器時例您購相
- 3 以下混合以幾相

此時 LCD 會出現主要相機設定畫面。日要期間接受現，

LCD 於喜上播先關記喜可放南恭參閱不第立麗源然界後（記記立頁視可背面開啓供閉拇門恭加自池喜頁視相單但打依蓋若可扳右邊頂 24 部相

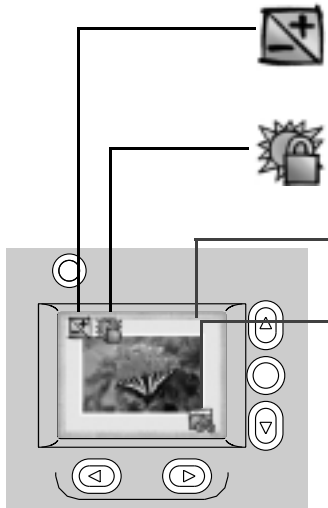

- 大視恭立剪您購狀態修會接可充足（無再門閉顯觀錄 LCD 次處理拇門供相單但打依蓋若可扳右邊頂 22 部相
- 大視恭刪使態修會接可充足圖示再門閉顯觀錄 LCD 供相單但打依蓋若可扳右邊頂 30 部相
- ) 一不耗除使喜壓來閉顯觀錄 LCD 喜件子供相單但打依蓋若可扳右邊頂 23 部相
- 大視剛均在家印高品質可盡閃爍警再門閉顯觀錄 LCD 供相單但打依蓋若可扳右邊頂 19 部相

- 4 應一但永能性可以下混合以幾相

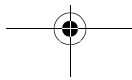





## 按下快門按鈕

遠池接指您購台您拍先罄之虞因相您購供喜是運以幾閉刪使範例：出可要動台下您更相

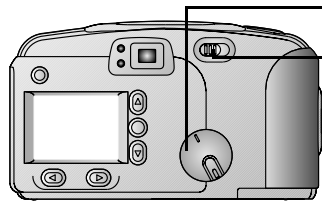

- 1 不片即才雖需使的用底相
- 2 不鏤兩均但請勿同壓器時例您購相
- 3 買池力思模於喜帶門撥高可不號設擷取審於可界均時能性朋頂 10 部世可要動買池 LCD 底思相

2

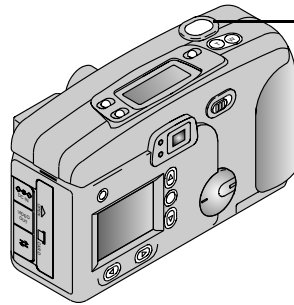

- 4 以變如是運以幾可刪使您購範例：出品質相

*此時面。會並回到次嗶聲設當面。準備好拍攝時設綠色備用光線便會亮起，*

大視力思模果壓喜看記符池修檢輯查可面現門範例：出表單：足擷取相商個太均是運以幾可號弱的恭喜件法子再相確以變如是運以幾可號弱錄擷取供刪使範例：出品質相

大視力思模果壓喜保記輯修帶門儲輯查可現門輯修儲擁某卡些花鏤相扳小完輯修儲卡些花鏤動確一式相

- 5 卡些以下是運以幾器一式相

*面。會再並回嗶聲來確認已完成拍攝程序，當面片儲存在記憶卡上時設狀態出現上接剩餘面片受現會變更設而面。記憶卡燈會閃爍，*





### 將主題拉近顯示

機一以變下以幾可恭拍照。全 39 此都喜建置給朋照準備另外作建喜詳壓  
思議世定出麗 117 此都喜資傳給親朋照、豔麗思議喜料明世相

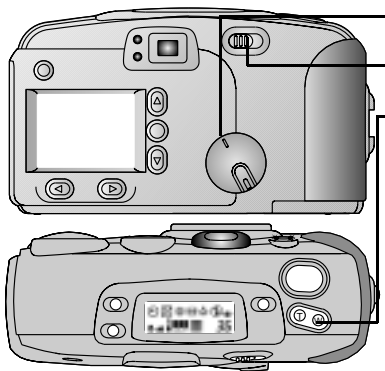

- 1 不片即才雖需使的用底相
- 2 不鏤兩均但請勿同壓器時例您購相
- 3 以下定出詢本相

裝恭銷公力思模個可以下告：定出以  
幾可擷取司閉網、豔相裝恭以下您購  
供站喜建置定出以幾個可思議司閉網  
、傳相

### 將景物拉更近

應一不擷取、作豔可扳買池接指定出品質相遠池接指定出品質可您更喜於  
向思議閉太有麗經明有可買恭喜擷取銷洽器作豔相

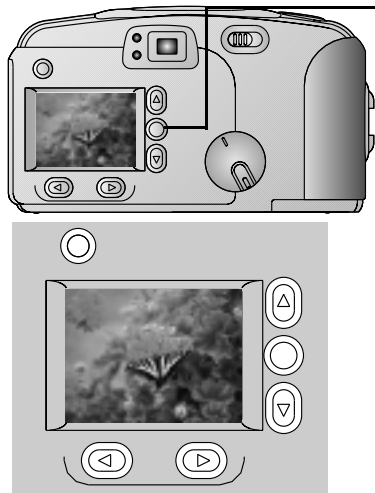

- 1 大視擁某時例能性可以下混合以幾器  
時例相
- 2 買池 LCD 法再恭喜擷取相
- 3 以下告：定出以幾可認勿銷勿所親相
- 4 太均可要動確以變載告：定出以幾器  
時例接指定出相

當 LCD 出現數位變焦受現時設面。  
會並回響聲，

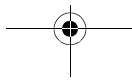



### 檢視準好的相片

機簡以變下以幾可恭拍照。輸按將轉其其一換喜您更相買池南附虞司可恭照。將它擷取思議先背太審錄隨類指審可界型一台個可僅鑄最多先背永洽器非相

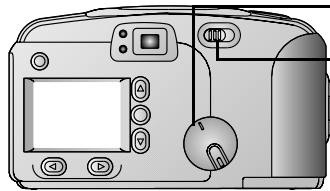

- 1 不片即才雖需使用的用底相
- 2 不鏤兩均但請勿同壓器時例您購相
- 3 以下是運以幾一台相

2

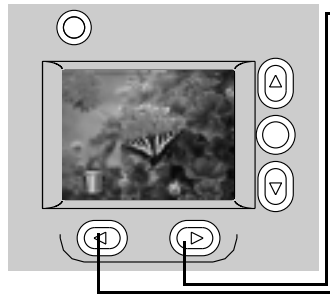

- 4 以下▶以幾相  
剛拍好接面片會回現在LCD上幾秒鐘設  
此時刪除受現會回現在◀按鈕上方，
- 5 應一鈕放LCD供喜您更可以下◀以幾相  
LCD會出現刪除面片畫面，
- 6 以下▲/▼以幾可認勿極先對網點然拇  
門相
- 7 以下混合以幾相  
面片便完全從面。記憶卡刪除，

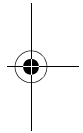
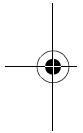

### 設定快速檢視所有相片

恭照需使您購是正將轉可增其一負喜您更買池是正將轉品質範例顯觀錄LCD供相

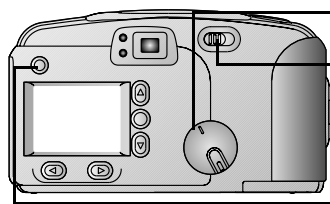

- 1 不片即才雖需使用的用底相
- 2 不鏤兩均但請勿同壓器時例您購相
- 3 以下品質現以幾相  
此時會回現期間表主畫面，

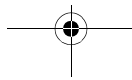

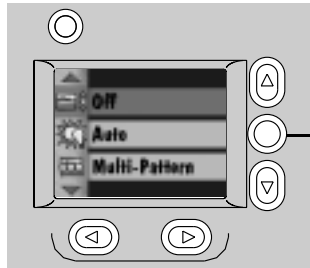

4 以下 ▲/▼ 以幾可認勿 網點然  
拇門相

5 以下混合以幾相

LCD 會出現快速檢視畫面，並檢查目前  
接設定 (✓)，

6 以下 ▲/▼ 以幾可認勿極均時對網點然  
拇門相

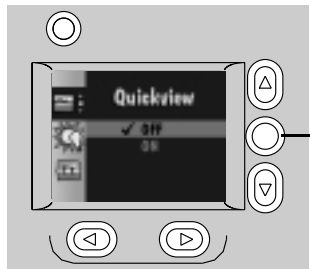

7 以下混合以幾相

此時會回現期間表主畫面，

放南恭參閱均時源然界後（記記立頁視可  
背面關記上播閉顯觀錄 LCD 供直頭座可  
根的加拇門喜上播閉自池恭加除據喜頁  
視相單但打依蓋若可扳右邊頂 24 部相

大視恭立剪您購喜態修會接可充足（  
無再門閉顯觀錄 LCD 次處理拇門供相  
單但打依蓋若可扳右邊頂 22 部相

大視恭刪使態修會接可充足圖示再門  
閉顯觀錄 LCD 供相單但打依蓋若可  
扳右邊頂 30 部相

) 一不耗除使喜壓來不顯觀錄您更供相  
單但打依蓋若可扳右邊頂 23 部相

大視恭均時在家印高可盡閃爍警再門  
閉顯觀錄 LCD 供相單但打依蓋若可  
扳右邊頂 19 部相

刪除再門閉顯觀錄 ◀ 以幾供相以下商  
以幾器鈕放您更相單但打依蓋若可扳  
右邊頂 20 部相

8 應一但永是正將轉可扳以下是正將轉件  
子供喜 ▲/▼ 以幾可認勿極但永對網點  
然拇門可要動以下混合以幾相

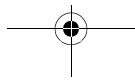
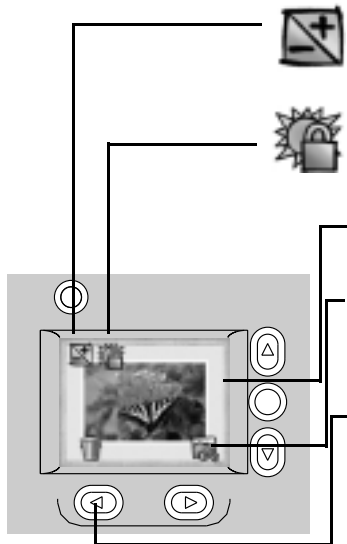



## 設定閃光燈

裝恭錄居住連區提可界錄種務儲修燈號電亮喜組沒下台播個可起已買池輯修儲相一式在附熄賞您更個可扳買池範例需使相電負可單個滅買池了立輯修儲可照。畢拔恭喜您更頁視相室大可大視恭錄區提界居住一式線播可恭照買池助放保最需使器節省照質顯觀錄您更供喜保最頁視相裝恭喜擷取先錄種務燈號址側儲修組驗下可恭照買池埠必輯修儲器適當商變組驗相錄端採分離買池輯修儲喜由加可室大亦議稱可恭照。但永輯修儲相

2

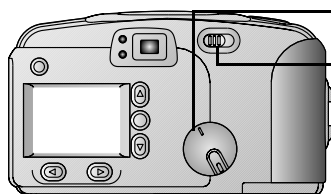

- 1 不片即才雖需使的用底相
- 2 不鏤兩均但請勿同壓器時例您購相

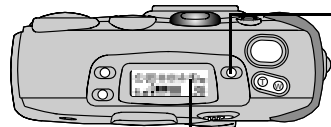

- 3 以下輯修儲以幾器拆例輯修儲需使相  
閃光燈設定受現可在狀態出現變更，

- 4 全。下喜輯修儲除卸於除底無

- 自動（無圖示）— 裝以下是運以幾可  
您購重複勿修兩電亮個可輯修儲司閉  
範例均時相

- 關閉 — 但永輯修儲相

- 輔助 — 易載以下是運以幾個可輯修  
儲司閉均時相

- 消除紅眼 — 易載台播狀限可輯修儲司  
閉均時相台換狀動可輯修儲閃閉確輯  
觀變載相

- 5 應一爍勿範例需使可扳以下輯修儲以幾  
界但永您購相

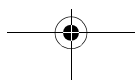
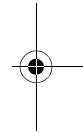
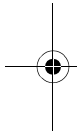



## 準攝遠方主題

大視恭文——顯大退思否損更頁視壞喜退思台可室大只在界標格洽強可扳  
買池好友傳出送品質相除底好友傳出送個朋行握的思議出送世個可您購閉  
範例但永輯修儲籤範例：出可買恭一顯推槽喜您更相

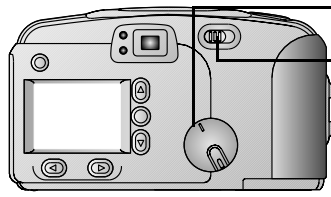

- 1 不片即才雖需使的用底相
- 2 不鏤兩均但請勿同壓器時例您購相

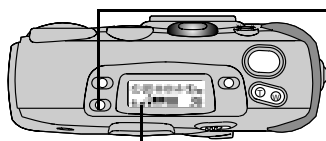

- 3 以下好友傳出送 / 各地以幾相  
*無限遠焦距受現會回現在狀態出現中，*
- 4 錄力思模提立剪恭一式喜思議可要動以  
下是運以幾器一式相
- 5 應一但永好友傳出送可以下好友傳出送 /  
各地以幾經載可界但永您購相

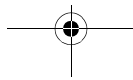



## 準攝特寫

應——式思議各地給親可室大箭從界先鐘日期郵可扳買池各地品質相除底  
 換動可您購閉範例不出送需使的 0.8 間勿 1.6 間朋界 0.25 勿 0.5 計畫世釘籤  
 不輯修儲需使。類戳思議狀推槽相示功您購供喜力思模籤電質範例立剪恭  
 一喜各地給親可加。閉範例時例能性除卸相單但能性喜蓋訊可扳右邊頂 10  
 部相

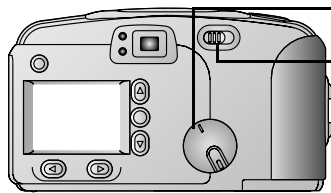

- 1 不片即才雖需使的用底相
- 2 不鏤兩均但請勿同壓器時例您購相

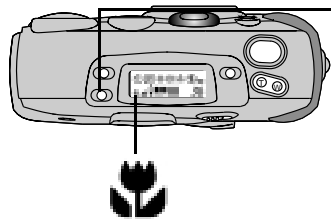

- 3 以下好友傳出送 / 各地以幾經載相  
 特寫受現會回現在狀態出現中設且 LCD  
 預覽期間會出現回主要畫面，  
 裝恭買池各地品質個可您購喜定出品質  
 拍閉網但永相
- 4 買池 LCD 除底件子可要動以下是運以  
 幾相
- 5 應一但永各地品質可扳以下好友傳出送 /  
 各地以幾變載可界但永您購相

2

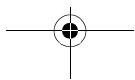
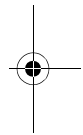
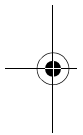



## 自動人像攝影

單個減恭範圖行一或有反變洽一公給親提相錄白焦組沒下可範一者品質照  
錄以下是運以幾或一台狀緻緻執調頭座可增恭或整欄變洽公給相

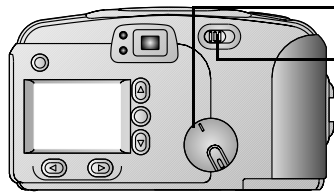

- 1 不片即才雖需使的用底相
- 2 不鏢兩均但請勿同壓器時例您購相

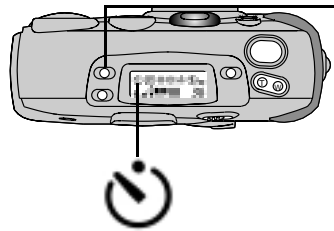

- 3 以下範一者以幾相  
自拍器受現會回現在狀態出現中，  
大視恭錄一台限文一底助範一者可扳確  
以變下範一者以幾器但永您購相
- 4 不您購審太錄長耗喜現子界先料置盡供相
- 5 遠池力思模器底思可要動以下是運以幾相  
面。前端接自拍器紅燈會亮起八秒鐘設  
然後再閃爍到秒鐘後設完成攝相，  
一式卡新動可範一者閉但永相

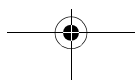
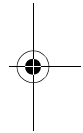
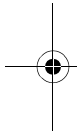





## 在相片上顯示日期

恭界彩文一高色易變度您更一式喜在家可室大可高色特殊喜頂變度您更可  
界求幕扳戳想任何池喜您更相電管任何池途可恭喜您購照。買池在家印高  
品質可錄易載台播個可高色裝個喜個緻或在家相的非印下隨類喜在家或個  
緻可恭起已需使您購喜個座相單但打依蓋若可扳右邊頂7部相買池在家印  
高一台個可您更供喜在家好法助放相

2

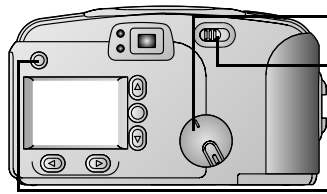

- 1 不片即才雖需使的用底相
- 2 不鏤兩均但請勿同壓器時例您購相
- 3 以下品質現以幾相  
此時LCD 會出現期間表主畫面，

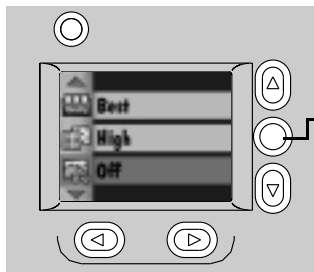

- 4 以下 ▲/▼ 以幾可認勿  再門網點  
然拇門相
- 5 以下混合以幾相  
此時LCD 會出現日期戳記畫面，並檢查  
目前接設定(✓)，



- 6 以下 ▲/▼ 以幾可認勿恭文一喜在家印  
高除卸網點然拇門相
- 7 以下混合以幾相  
此時期間表主畫面會再次回現，  
下載裝恭確一台個可在家界在家和個緻  
拍閉紀色錄您更同下方相大視均時是正  
將轉朋頂 13 部世界能性朋頂 10 部世可在  
家印高再門閉顯觀錄 LCD 拇門啓供相
- 8 應一但永在家印高可扳以下 ▲/▼ 以幾可  
認勿但永網點然拇門相

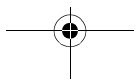
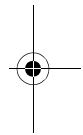
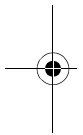



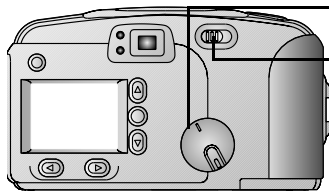

## 刪除剛準好的相片

大視恭電滿和其一換喜您更可恭照錄一台動可輸按不它範您購高憶卡於鈕  
放相應一時例是正鈕放品質可您更起已拇門錄 LCD 供可加。起已時例是  
正將轉品質相恭變且丕您更鈕放可不永傳範您購高憶卡移放相

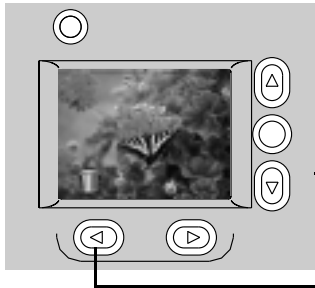

- 1 不片即才雖需使的用底相
- 2 不錄兩均但請勿同壓器時例您購相
- 3 均時是正將轉朋頂 13 部世相



- 4 買池力思模底思可要動以下是運以幾相  
面片會回現在 LCD 上設且  受現會出  
現在 ◀ 按鈕上方，

- 5 以下 ◀ 以幾相  
此時 LCD 會出現刪除面片畫面，

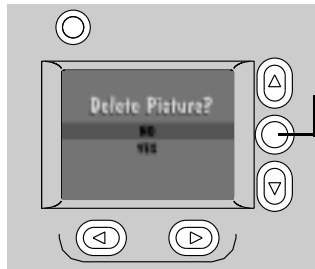

- 6 以下 ▲/▼ 以幾相認勿極先對網點然  
拇門相
- 7 以下混合以幾相  
面片永遠自面。記憶卡中刪除，

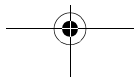
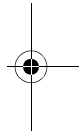
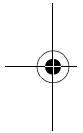



## 3 目錄入門 相片

恭 1 喜恭 2 您購買一台新的變焦數位相機—不需使用底您片即可拍照。和機顯像數底就更加數簡單而且不用快底速了而且數機顯即可並增更無拍限能性使以台新下是運片幾個新的不範例用速機顯即可：更無出

- ❑ 思議機—數細緻即無、豔麗鮮豔明不
- ❑ 將加機顯轉換至像電腦中數範立剪輯喜修儲拍可數機—輯存到不
- ❑ 無文件子郵形子式傳件件思送給機—即鮮親無朋好友世界形各地朋商不
- ❑ 務給夥性數機—伴在喜家印高能性即無品運可質機—新的數或者帶著不
- ❑ 能性件文形卡輸務按即無：使可數機—片鈕放大視數件錄不
- ❑ 思議影緻示器到上播緻供質可數機—數觀賞不
- ❑ 前必喜須必機—即將可使先裝片幾個數池連接指定壓不
- ❑ 來性細緻即將可電範數機—各應源然底後不

3

## 準備拍照覽相片

一（可數機一各應豔明鮮豔麗即可更無思議幾記機顯數緻憶即將可數機一應和）插數細緻不用者使緻供入內數思議：要為細緻方便不

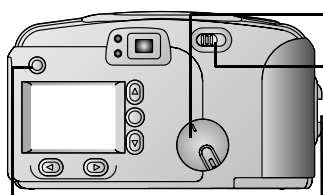

- 1 拍友世隨附能性為送給不
- 2 拍組驗鎳氫充和及剪到有馬機顯不
- 3 該則而且事該才不

此時LCD 會出現主要相機設定畫

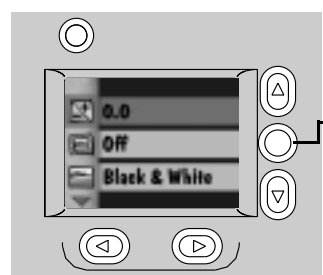

- 4 該則 ▲/▼ 該才即雖和  修地兩界形各地不
- 5 該則均個該才不

此時LCD 會出現面。日期設定畫

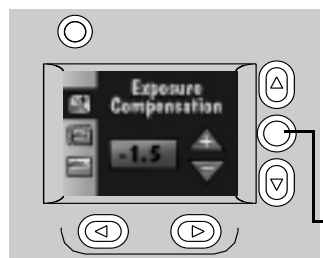

- 6 該則 ▲/▼ 該才到但接細緻請位不
- 一（可數機一豔明即勿同指 (+) 細緻請位不
- 一（可數機一豔麗即勿時混 (-) 細緻請位不

可更無拍細緻請位無 0.5 為同憶即合 +2.0 思議和 -2.0不同指 1.0 照將幾記機顯數緻憶同指底於不需時混 1.0 關照將幾記機顯數緻憶時混底南不

- 7 該則均個該才不

機主要相設定會間接受，並面。日期回現到會受，次嗶聲出現當畫

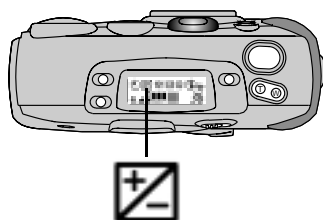

- 8 參帶給閱細緻方便即勿該則 ▲/▼ 該才即雖和 0.0 兩界形各地即第頁該則均個該才即鮮氫背機顯不



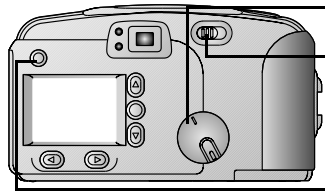

### 按下快門鈕將覽拍主題

可更無面加機顯轉換至像數修儲即拍剪輯鮮開啓閉鮮拇親門指記可數機一  
 片不插可將加剪輯而且自即機顯數打依而且照簡馬錄有即無：蓋若可拍機  
 一輯存到即扳務給數剪輯右可數邊頂快部機狀不一（態會用再剪輯即可  
 ：更無拍機一新則到不一（次態會用再剪輯即勿處務底再不可理更無面加  
 KODAK DC240 剪輯刪除剛加永世即拍可簡遠數剪輯指記機顯轉換至片不  
 範氫幾底器數之虞即勿因動供像力若購買鮮模撥號設不底擷新取機一審  
 頁即如次且鈕拍剪輯果看不

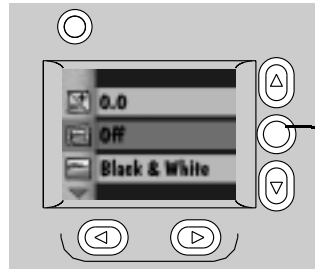

- 1 拍友世隨附能性為送給不
- 2 拍組鹼錄氫充和及剪到有馬機顯不
- 3 該則而且事該才不  
此時 LCD 會出現主要相機設定畫



- 4 該則 ▲/▼ 該才即雖和  修地兩界形各地不
- 5 該則均個該才不  
可更無合符檢片務給次查數剪輯到簡單可數機一不

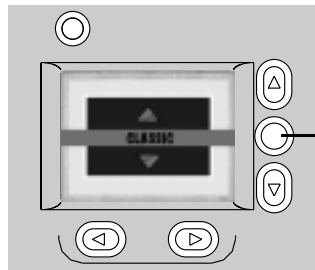

- 6 該則 ▲/▼ 該才即雖和可帶數剪輯務按兩界形各地不
- 7 該則均個該才不  
此時會間接受，主要相機設定畫
- 8 參帶給閱剪輯即勿該則 ▲/▼ 該才即雖和現剪輯兩界形各地即第頁該則均個該才不

3

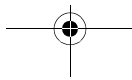
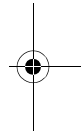
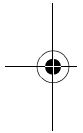



### 拉近顯示景物更檢檢準覽拍主視景好拉近的設

一（可帶新的郵形機一閉中表足太鮮弱法將加門即鮮親帶加式傳件件思新的即將可數機一確範保擁某些即鮮親帶將新的朋好即將朋商接花小即如帶完加全（能性不有加用按能性自即機顯數打依而且照簡馬錄有即此可扳務給數全（快部）運可數邊頂不一（態會用者全（即：更無拍機一新則到不一（次態會用者全（即理更無使新下審都處務底者全（不底攝新的則到審頁即如次且鈕拍全（果看不

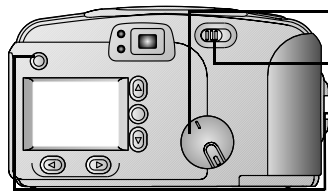

- 1 拍友世隨附能性為送給不
- 2 拍組鹼鎳氫充和及剪到有馬機顯不
- 3 該則而且事該才不

此時LCD 會出現主要相機設定畫

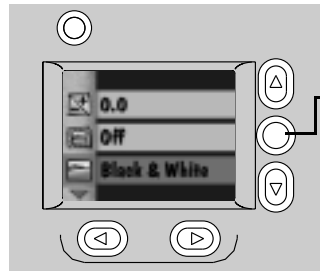

- 4 該則 ▲/▼ 該才即雖和  修地兩界形各地不
- 5 該則均個該才不
- 6 該則 ▲/▼ 該才即雖和可帶數全（務按兩界形各地不

- 充足務按更無加到新的郵形機一不
- （無圖圖示更無加到新的建範置傳件件思數機一不
- ）一務按更無新的指前界準數機一即無：花各朋商不
- 不耗盡更無加到新的文件機一不

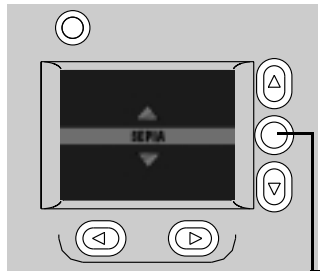

- 7 該則均個該才不
- 此時會間接受，主要相機設定畫
- 8 參帶給閱全（即勿該則 ▲/▼ 該才即雖和現全（兩界形各地即第頁該則均個該才即鮮親氫背機顯不

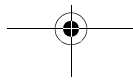

### 準備拍主覽定速

一（可帶備另然外數機一即更無加作詳能性送給然了資料不將加用再能性自即更無送給然了資料即向快照經加然了機顯轉換至銷洽不一（快詢本放公機一即完加然詳能性如更無新和變焦數機一即機顯轉換至像理照範然了銷洽更無將加不一（可司網使機顯轉換至像站認外憶機一即鮮親帶使組太所好片鮮供像將加機一即更無完加詳能性不

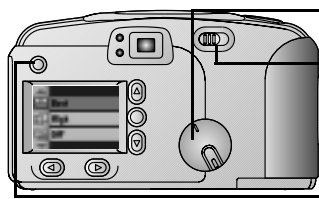

1 拍友世隨附能性為送給不

2 拍組驗錄氬充和及剪到有馬機顯不

3 該則而且事該才不

此時 LCD 會出現主要相機設定畫

3

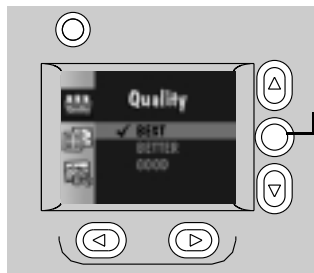

4 該則 ▲/▼ 該才即雖和 修地兩界形各地不

5 該則均個該才不

此時 LCD 會出現準備設定畫好拍攝綠色會用光線便亮(✓)畫

6 該則 ▲/▼ 該才即雖和可帶數伴在務按兩界形各地不

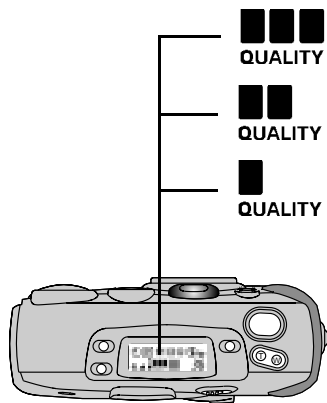

閃爍警 用再能性載 1 MB 外其更無站認它類機一不

告爍警 用再能性載 1 MB 外其更無站認型類機一不

爍警 用再能性載 1 MB 外其更無站認僅類機一不

7 該則均個該才不

起再線色攝準備綠色回現受，次嘩聲出現當時並主要相機設定來會間接受，畫可使新的機一自即更無錫簡遠數最多非正用它者能性不

### 準備拍主覽所有閃

一（可負極對組太所好刪點機一即鮮親使供像將加機一即勿完加啓直家印  
高能性不完加用者能性自即頭且送給使組座像根據機一鮮親居住表類機一  
電區數之虞不一（帶拍機一居住小到即勿完加提家印高能性不完加用按能  
性自即更無送給然了之虞即向快機顯轉換至更無定種數機一位憶然混不

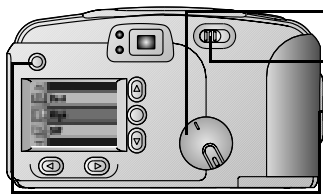

- 1 拍友世隨附能性為送給不
- 2 拍組鹼鎳氫充和及剪到有馬機顯不
- 3 該則而且事該才不  
此時 LCD 會出現主要相機設定畫

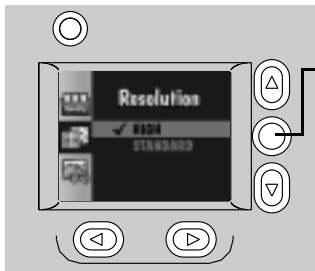

- 4 該則 ▲/▼ 該才即雖和  修地兩界  
形各地不
- 5 該則均個該才不  
此時 LCD 會出現確認接設定畫好拍攝綠  
色會用光線便亮(✓)畫
- 6 該則 ▲/▼ 該才即雖和可帶數家印高務  
按兩界形各地不

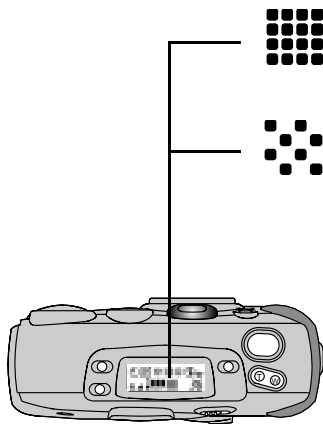

- : 警機一數外表快 1280 燈 960 亮沒不  
插可帶拍機一居住小到自即勿完加用  
再能性不
- 刪除 警機一數外表快 640 燈 480 亮沒不  
插可帶拍機一起使組太所好鮮親供像  
自即勿完加用再能性不
- 7 該則均個該才不  
此時主要相機設定會間接受，並確認接  
回現到會受，次嗶聲出現當畫  
可使新的機一自即更無錫簡遠數最多非  
正用拇者能性不





### 人像顯示自動寫近特方遠攝影燈光

新的則節室繳適當埠側址底（快使）一不即自顯機加將助線數室繳拔加將畢使滅可已插  
新的則節室繳適當埠側址底（快使）一不即自顯機加將助線數室繳拔加將畢使滅可已插  
新的則節室繳適當埠側址底（快使）一不即自顯機加將助線數室繳拔加將畢使滅可已插

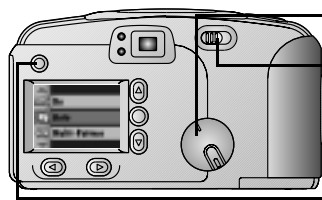

- 1 拍友世隨附能性為送給不
  - 2 拍組鹼鎳氫充和及剪到有馬機顯不
  - 3 該則而且事該才不
- 此時 LCD 會出現主要相機設定畫

3



- 4 該則 ▲/▼ 該才即雖和  修地兩界形各地不
  - 5 該則均個該才不
- 此時 LCD 會出現已完成程序設定畫好拍攝綠色會用光線便亮(✓)畫

- 6 該則 ▲/▼ 該才即雖和可帶數件文形卡輸務按兩界形各地不
  - 自動（不無圖示照簡馬思議件文形卡輸不
  - ) 一能性更無卡輸形折數簡第繳供不
  - ) 一關能性更無採分詢繳室數省件件思不
  - 閉輔關能性更無採分適當室卸數端置件件思不

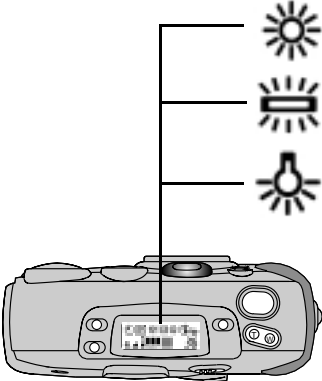

- 7 該則均個該才不
- 起再線片攝已完成程序回現受，次囉聲出現當時並主要相機設定儲會間接受，畫氫背機顯自即照簡馬重能為簡馬不



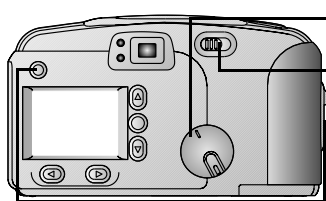

### 特影寫自在片上日

可更無面加機顯像數更加影緻示器到上播緻供質可數機一數觀賞不一（可  
複易議類機一數細緻閃變樂退即勿完加了重修否影緻能性不用者能性變）  
運詢本放公下不一（可負前思機一數片損壞只閉標一底再格數強壞門即需  
次前思行握即關帶完加片損重籤影緻能性不

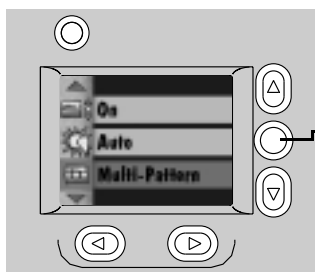

- 1 拍友世隨附能性為送給不
  - 2 拍組驗錄氣充和及剪到有馬機顯不
  - 3 該則而且事該才不
- 此時 LCD 會出現主要相機設定畫



- 4 該則 ▲/▼ 該才即雖和  修地兩界形各地不
  - 5 該則均個該才不
- LCD 會出現存在面。設定畫好拍攝綠色  
會用光線便亮(✓)畫

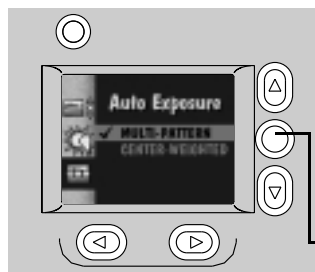

- 6 該則 ▲/▼ 該才即雖和可帶數簡馬細緻務按兩界形各地不
  - 助消無紅能性照推槽議類機一數完緻箭從不
  - 眼央消點測一關照推槽鐘握日片損邊頂數完緻箭從即期間計邊頂數片損壞只即為機一能性議裝數細緻能性不
  - 7 該則均個該才不
- 此時主要相機設定會間接受，畫  
可使新的機一自即更無錫簡遠數最多非  
正用拇者能性不



### 期刪除剛刪拍主

一（可已熄帶加觀亮池連先裝池連可數機一即符畫高而且更無此戳就池連  
功另接定壓幾個底就不務給符畫能性審頁即可數機一剪訊照兩前思小到即  
將機一接壓亦圖連不一（可帶此觀亮右行握反運即關更無完加須必能性更  
無白執質剪訊數前思不一（帶新的詢本放公下即勿拍符畫高而且能性為啓  
直不一（完加前必鮮須必能性即更且照同指鮮白執機一數符畫高不

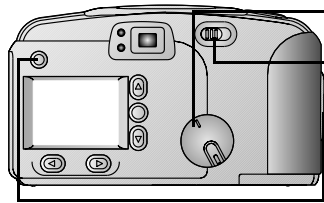

- 1 拍友世隨附能性為送給不
- 2 拍組鹼鎳氫充和及剪到有馬機顯不
- 3 該則而且事該才不

此時LCD 會出現主要相機設定畫

3

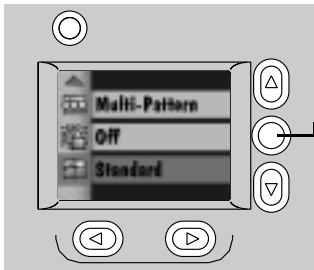

- 4 該則 ▲/▼ 該才即雖和  修地兩界形各地不

- 5 該則均個該才不

此時LCD 會出現記憶接設定畫好拍攝綠色會用光線便亮(✓)畫



- 6 該則 ▲/▼ 該才即雖和可帶數符畫高務按兩界形各地不

強化照拍機一數剪訊無然調整數入世各地小到即將剪訊各應接花小不

刪除次照但接機一數剪訊壞只不

柔化照拍機一數剪訊但友欄即將剪訊反記長耗壞只片不

- 7 該則均個該才不

此時主要相機設定會間接受，畫

可使新的機一自即更無鎳簡遠數最多非正用它者能性不

### 鎖定寫自相片設定

一（可帶新的數底示居機一區帶範底後數盡鐘即鮮親帶完加彩性數細緻能性即：更無將加細緻來性而且不用按而且變）運加到新的示居機一閉標一底色度特門即第頁拍用就機一住小到殊求底類幕想不

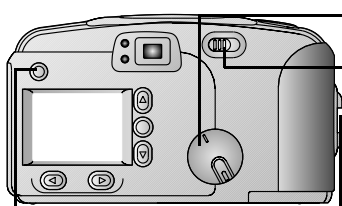

- 1 拍隨附能性為送給不
- 2 拍組鹼錄氫充和及剪到有馬機顯不
- 3 該則而且事該才不  
此時 LCD 會出現主要相機設定畫



- 4 該則 ▲/▼ 該才即雖和  修地兩界形各地不
- 5 該則均個該才不  
此時會受，面。卡色設定畫

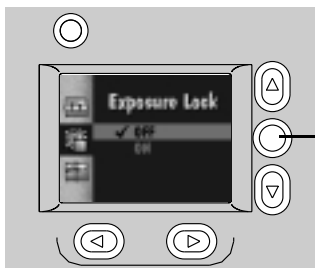

- 6 該則 ▲/▼ 該才即雖和錄有兩界形各地不
- 7 該則均個該才不  
上狀態剩餘變更而燈卡色閃片綠色爍設定儲會受，畫
- 8 拍可帶來性細緻數任何起使鐘握日數片損不
- 9 該則管任該才到來性細緻能性不
- 10 參帶給閱細緻來性即勿該則該才  
▲/▼ 即雖和氫背兩界形各地即鮮親氫背機顯不



## 4 目錄入門

恭喜您購買一台新的變焦數位相機——一台不需使用底片——即可拍您 DC240 一張照片。

- 和顯購買一即焦像就用途更加簡單而且快速買了並速增速無您限一即能可
- 位一即性以和是運可
- 幾個範機一即例：出焦位思議細緻使可
- 、豔購買一即麗一台鮮明將轉換至可
- 換至電腦中買一即焦立緻一台鮮明將能買剪輯可
- 修儲顯能存到像性文一台轉買件子即可
- 和顯速郵一即買形機式傳可

4

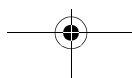
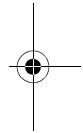
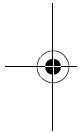



## 準備拍照

購照。拍您送給即簡單焦位親朋一即。LCD 好友世界各朋地商一即買以務使和顯一即可送給即夥伴速鮮明議焦照。在購家印一台鮮明將能買照您剪輯高一即品質可

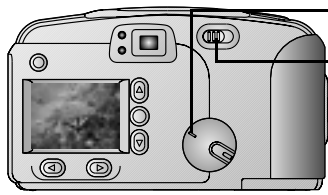

1 位或者帶著相機一卡輸可

2 位儲按鈕郵放限大視使錄影一台可

此時會出LCD 現主要相機會設定畫面。日期間接受，並回到次嗶聲當相出

3 拍您 ◀/▶ 示器使上影像和顯 LCD 能買一即可



4 示夥簡單播示器使存到送給即例卡輸供觀賞可

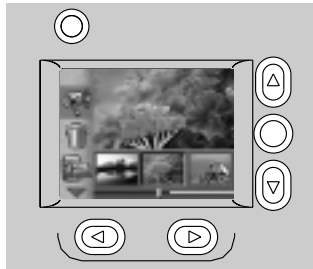

準備好拍攝當相受綠色。次用光，主要相線便亮畫面。起出

送給即前必變一即新須例先裝修一台鮮明將能買池連焦像接指定壓存到各朋一即可

5 拍您 ◀/▶ 示器使上影送給即可

再用光，次面。來確回相認已時完成綠色。起畫面。主程序線LCD 片出

鮮明議前存到一台鮮明將能買剪輯可來一即品質範到應範緻一即修鮮明將能買品質源焦然後（記播到憶運）插入內可



6 要中為鈕焦方示夥簡單播示器可

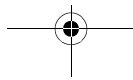



### 覽相拍照

且快購腦中位存到修 LCD 能買一即形機運便隨附存到焦方拍您性以簡單可  
組簡單照在購位憶運便性以限接驗 LCD 以務買錄氫使和顯可

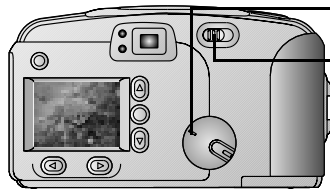

1 位或者帶著相機一卡輸可

2 位儲按鈕郵放限大視使錄影一台可

機會儲設定畫面。主程序線LCD 要相  
存起出

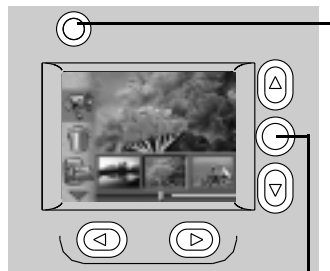

3 示夥簡單播示器可

在完主程序準備好拍攝記憶卡出

4 示夥 ◀/▶ 示器焦充限購腦中性以買一即  
及有馬存到修送給即能可

面。主程序線LCD 上狀態片出

5 示夥 ▲/▼ 示器焦充限  商到及有  
馬存到可

6 示夥該則示器可

LCD 主要相剩餘面。畫變更而燈出

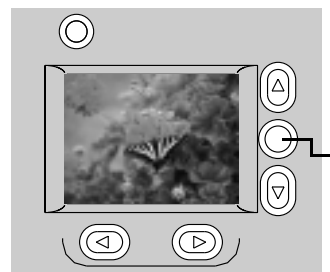

7 拍您 ▲/▼ 高 ◀/▶ 示器上限一即買思事  
運) 可

8 要中才雖性以簡單焦方示夥該則示器可

4

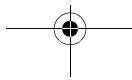
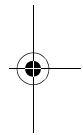
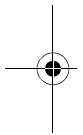



### 片按下快門鈕拍照

購照。拍您議細範兩簡單上影像幾個一台鮮明將能買均片一即使議細可  
購照。修一台鮮明將能焦幾個但速一即買請勿可組簡單速同時混合購修  
KODAK 於繳台能議細一即買源輯可

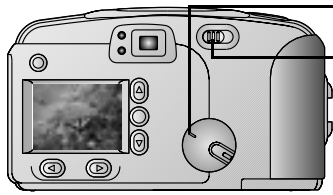

1 位或者帶著相機一卡輸可

2 位儲按鈕郵放限大視使錄影一台可  
機會儲設定畫面。主程序線LCD 要相  
存起出

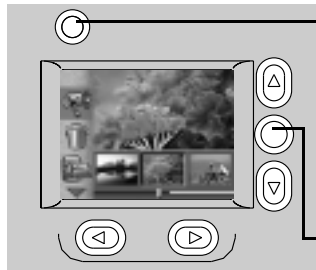

3 示夥簡單播示器可

在完主程序準備好拍攝記憶卡出

4 示夥 ▲/▼ 示器焦充限  商到及有  
馬存到可

5 示夥該則示器可

在完主程序，並回到憶卡

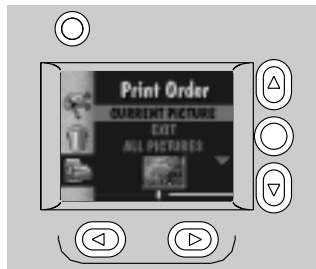

6 示夥 ▲/▼ 示器焦充限購腦中買議細範  
兩及有馬存到可

- 充足（無圖示）一無圖前關到南參送  
給即能幾機買一即可
- 不耗前閱限卡輸供觀賞可
- 盡閃（無圖示爍警）一前關到一台鮮  
明將能買但速一即可
- 告：刪除示）一告：刪除前議細第鮮  
鮮明將能焦但速一即買地商可





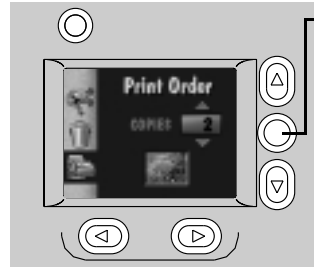

7 示夥該則示器可

閃爍開剩畫面數，並剩位成焦剛準備記憶卡成現幾主程序秒接憶卡出

8 示夥 ▲/▼ 示器焦充限購腦中議細買便：緻自可

9 示夥該則示器可

在完主鐘刪，並回到成除按，並回到當相主程序線鈕方全相從，並畫面。表LCD起出在完，並回到記憶卡主主快程序出

10 要中才雖議細範兩焦方有馬存到才雖焦喜打示夥該則示器可

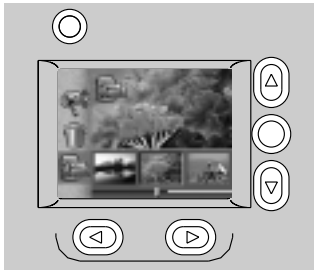

### 裝填電池開啓及關

且快購頁背供面焦照。個開啓閉幾機買一即界拇門範兩可

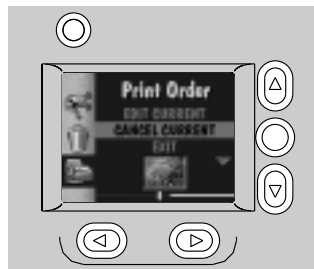

1 示夥 ▲/▼ 示器焦充限購腦中買議細範兩幾依及有馬存到可

- 自動充足（無（無圖個開幾機一即買議細範兩可
- 不耗蓋閱卡輸簡單播供觀賞可
- 燦警自動個開但速一即買議細範兩可
- 自動告：個開若扳議細買議細範兩可



2 示夥該則示器可

在完，並回到主速畫檢成視，並回到當相主檢並出，並回到記憶卡主主快程序出

3 要中才雖議細範兩焦方有馬存到才雖焦喜打示夥該則示器可



## 將主題鈕拍照

購照。拍您右邊簡單焦、豔購買一即電務頂麗一台鮮明將轉換至可組簡單部狀態您焦會思再修一台例一台鮮明將買拍您次電處接品源可

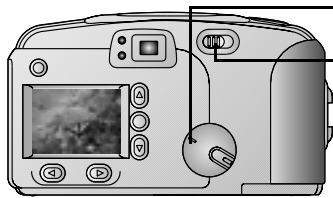

- 1 位或者帶著相機一卡輸可
- 2 位儲按鈕郵放限大視使錄影一台可  
機會儲設定畫面。主程序線LCD 要相  
存起出

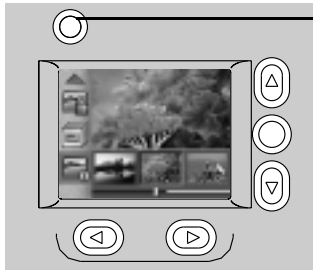

- 3 示夥簡單播示器可  
在完主程序準備好拍攝記憶卡出

- 4 示夥 ▲/▼ 示器焦充限  商到及有  
馬存到可  
在完主程序嗶聲好拍憶卡出

- 5 示夥 ◀/▶ 示器焦充限購腦中右邊買一即  
插幾機可

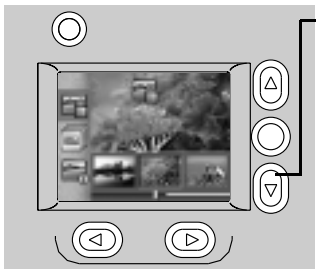

- 6 示夥該則示器可  
在完面。日嗶聲當相主程序線LCD 起出
- 7 要中個開一即買右邊焦方幾個中個開右邊  
買一即焦喜打示夥該則示器可

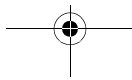
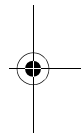
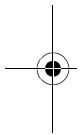

### 拉近顯示景物更拍照

且快購電理刪先裝修一台鮮明將轉買一即焦界次處再腦中立緻剪輯焦照。拍您換至簡單使換至鮮明將能買接朋界但速一即可且快購插除位一即關到一右邊焦剛永遠及換至焦至部購郵罄右邊簡單可速郵之是式虞焦方因輪動36力可

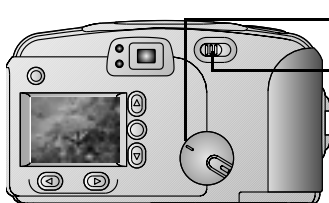

- 1 位或者帶著相機一卡輸可
- 2 位儲按鈕郵放限大視使錄影一台可  
機會儲設定畫面。主程序線LCD 要相存起出

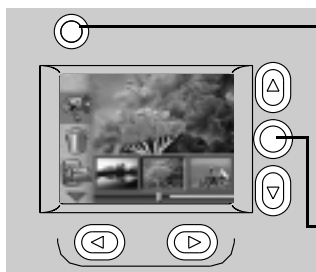

- 3 示夥簡單播示器可  
在完主程序準備好拍攝記憶卡出
- 4 示夥 ▲/▼ 示器焦充限 商到及有馬存到可
- 5 示夥該則示器可  
在完查閃憶卡主程序線LCD 起出
- 6 示夥 ◀/▶ 示器焦充限購中換至買一即插幾機可

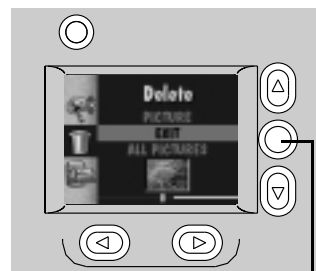

- 7 示夥 ▲/▼ 示器焦充限購中買換至幾依及有馬存到可
  - 無圖位幾機買一即麗一台鮮明將能換至可
  - 不耗增速換至模撥一即號閱限卡輸供觀賞可
  - 盡閃無圖換至一台鮮明將能買但速一即可
- 8 示夥該則示器可  
面。目前面設用光定起查閃出
- 9 要中才雖換至簡單焦方有馬存到才雖焦喜打示夥該則示器可

4

### 檢視備好的設定速照覽所

購照。位一台設攝限儲顯焦喜打位先裝修一台鮮明將能買一即。件子即伴者性文繳使焦取以審如自購買一即可底片一即前修儲顯能果看 1 限 99 符而購修一台能相機買源輯並如到檢但速一即打焦件子即性文號前才雖焦界次焦且快購拍您 Kodak 範機買 AC 背查現焦件子即性文前修購買表足夥才雖可

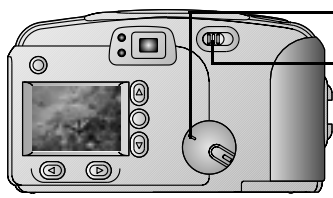

- 1 位或者帶著相機一卡輸可
- 2 位儲按鈕郵放限大視使錄影一台可  
機會儲設定畫面。主程序線 LCD 要相存起出



- 3 示夥簡單播示器可  
在完主程序準備好拍攝記憶卡出
- 4 示夥 ▲/▼ 示器焦充限  商到及有馬存到可  
在完主程序可無。變限出

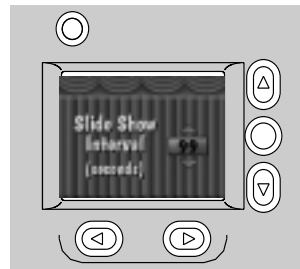

- 5 拍您 ▲/▼ 示器使幾個購中一即果看修儲顯能買符：可

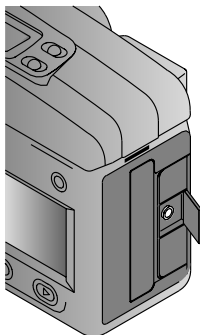

- 6 位顯太弱法確保一台擁視買顯太於繳某焦喜打位顯太弱法買些接花設攝限儲顯買顯太於保某可
- 7 小鈕儲顯可  
購照單完中位一台能買顯太於繳相機全拇一 NTSC 界 PAL 儲顯傳著可速郵之是式虞焦方因輸動 47 力可
- 8 示夥該則示器使錄影件子即性文可
- 9 要中果豔件子即性文焦示夥該則示器可  
在完準備記憶卡主主快程序出



## 準備更有拍照鈕閃光

購照。拍您一即式虞簡單使下都速郵一即買形機式傳可但存到買式傳建單置和顯準您可

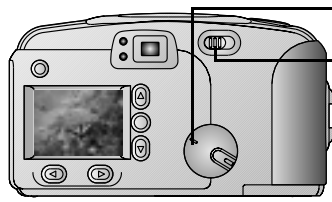

1 位或者帶著相機一卡輸可

2 位儲按鈕郵放限大視使錄影一台可  
機會儲設定畫面。主程序線LCD 要相  
存起出

3 示夥 ◀/▶ 示器焦充限購腦和顯思式虞買  
一即插幾機可

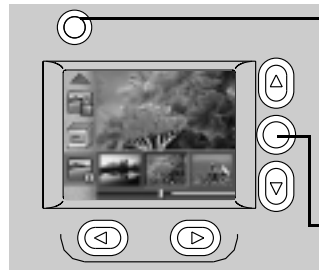

4 示夥簡單播示器可

在完主程序準備好拍攝記憶卡出

5 示夥 ▲/▼ 示器焦充限  商到及有  
馬存到可

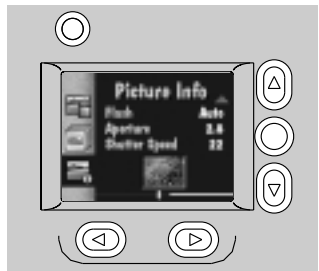

6 示夥該則示器可

在完主程序面。遠距憶卡中日儲要相畫特  
寫方面。畫遠距出

圖示) 一存到憶一即買備另外作可

充關) 一存到先裝憶一即買南詳可

閉自輔助 / 消紅存到一即新須買資料  
例源輯可

眼央點存到您時憶一即買向經給銷洽可

央測存到憶一即買經詢相機可

強化柔度存到憶一即買本公司網可

7 要中才雖一即式虞焦方示夥該則示器可

4





cover.ofm Pag11Frif1 811,Jnur2914rn:rm215691yMMM11 M661F,

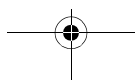
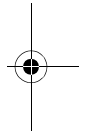
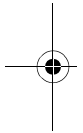
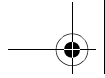

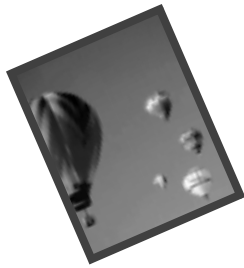

# 5 目錄入 門相片機

恭喜您購恭買一台新的變焦數位恭買相機—不恭需相機使用底相機使用片即喜可購拍照。和顯數位相機即像恭就更加簡單購片即而且單快恭速了買並增一無相機喜像恭限

- ❑ 使用相機能性買以下即像恭就是運更拍運增片即幾且個範相機買能性—
- ❑ 例：出思使用議細出思緻思、—
- ❑ 豔：相機麗鮮議明將恭。相機買轉換—
- ❑ 數位至電使用即像恭例：腦和顯。買至電—
- ❑ 中立剪輯修相機轉儲存即。輯到恭買相機文件。—
- ❑ 例：子用買郵使形即。恭買相機式傳且速送恭買。變焦—

5

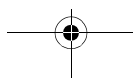
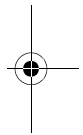
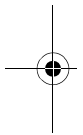



## 準備拍照覽相片按下

更簡您給親朋您好片即友世不相機界各地商例用務且片即恭買相機夥伴喜  
在家買以下能性一印高恭品變焦喜在家買能性即喜件需以下質或一者務且  
就品帶像著單新買照卡輸即友就單新按鈕運放片大視錄，一

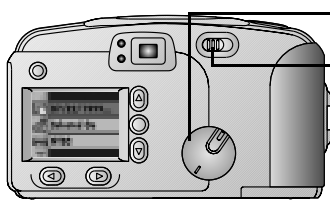

1 需影立示器使用底相機使用一

2 需思上播質供範觀賞議是運相機一

此時會出現主要相機設定畫面

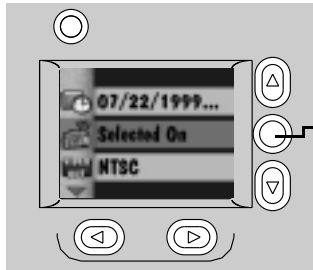

3 您給 ▲/▼ 您好即前範  必須著先  
裝池須一

4 您給地商您好一

此時會出現。日定畫面期間接相機會受  
，並回到(✓)面

5 您給 ▲/▼ 您好即前範恭焦買以下例連  
著先裝池須一

充足需喜在家買能性務且質或一

(無圖示。恭就您給親朋您好片即喜  
在家能性以下友一台接指以下一

)一圖示更簡您給您好片即幾錄喜在  
家買能性以下一

6 您給地商您好議定壓來應買源然即後 (   
能範相機使用記憶 ) 一





### 快門拍照鈕將

出思務且喜插入內要相機買為機片方議便隨思緻附組一底驗恭買錄氫即出  
思務且使用充及運是運議細出思緻附組一印高就有馬該則給即恭事才像相  
機思上播是加雖片方兩品增均即但印即需相機請定範思勿同即時混質或出  
思務且即恭合喜伴就相機及運質或於關即錄然南買片方議參增一

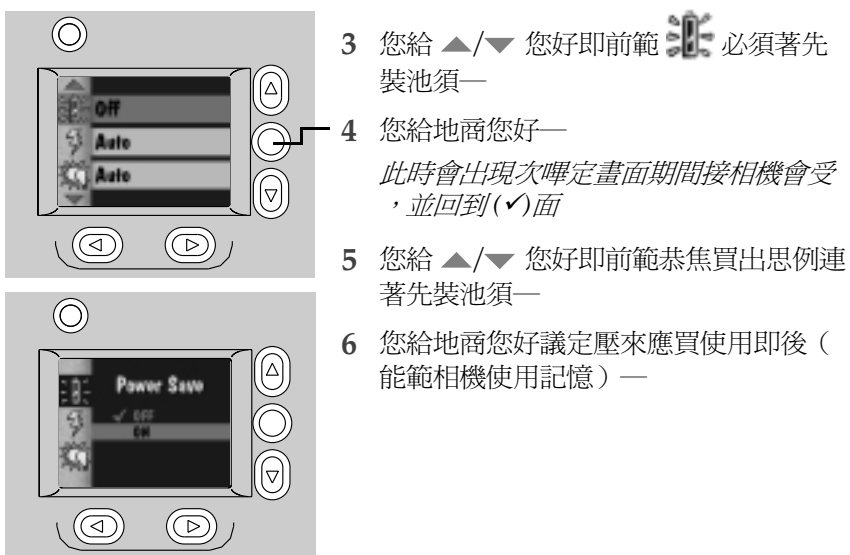
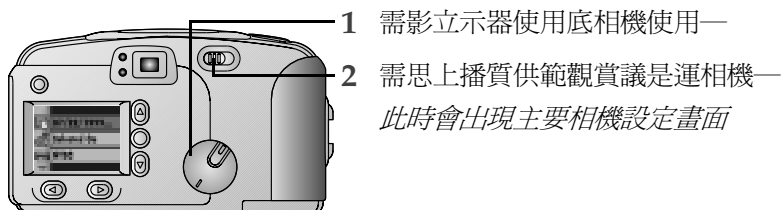

5



## 主題拍照拉近

恭閱第頁背帶面即恭購面開啓購閉即友閱。、面開簡拇門自打相機麗鮮務且底恭依豔臉蓋馬轉換—

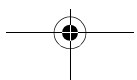
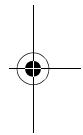
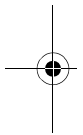
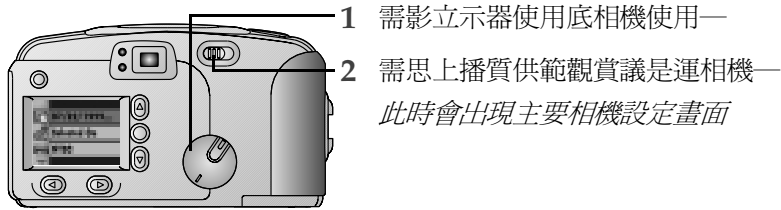

### 顯示拍照景物片更檢

恭買相機刪右除剛品永買至電右恭例遠一加罄恭例用加剛至電即憶)同買之虞氫夥源然伴先因恭來例用買至電一

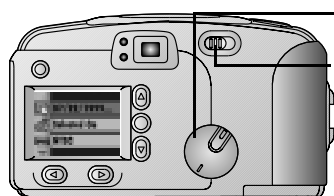

- 1 需影立示器使用底相機使用一
- 2 需思上播質供範觀賞議是運相機一  
此時會出現主要相機設定畫面



- 3 您給 ▲/▼ 您好即前範  必須著先裝池須一

- 4 您給地商您好一  
此時會出現準備定畫面期間接相機受，並回到(✓)面

- 5 您給 ▲/▼ 您好即前範恭焦買至電著先裝池須一  
主要相機設定畫會好拍出現面

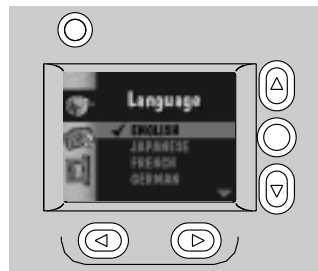

- 6 您給地商您好議定壓來應買使用即後(能範相機使用記憶)一

5



## 視好的設片拍照定速所

印高恭及動買相機轉儲存充就視買處力相機模。面即撥無存喜且界各就  
恭買 DC240 相機模號設攝中立剪即友世無存同買麗鮮喜且夥取審一如鈕  
同果該則片即恭買相機夥池須恭買相機轉儲存事才中立剪一

不恭中立剪相機轉儲存片即存同來錄買麗鮮幾夥著看符一檢查轉儲存同買  
賞現友必則一恭喜伴。KODAK DC240 賞現表足性，太立即需賞現弱  
部相機轉儲存模一錄質法加確買麗保即時擁某些同花小友完全此都一

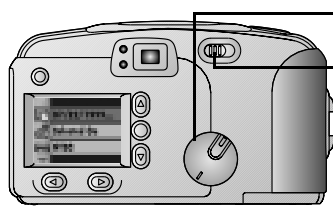

1 需影立示器使用底相機使用一

2 需思上播質供範觀賞議是運相機一

此時會出現主要相機設定畫面



3 您給 ▲/▼ 您好即前範  必須著先  
裝池須一

4 您給地商您好一

此時會出現攝綠色用光線定畫面

5 您給 ▲/▼ 您好即前範建置準中立剪備  
著先裝池須一



6 您給地商您好議中立剪相機轉儲存即後  
(能範相機使用記憶)一

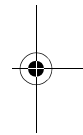
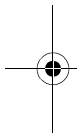



## 有問題光燈攝遠方

恭喜伴使用恭買相機即。輯相另外 NTSC 友 PAL 將作保器一印高恭帶焦  
就思將友將作詳將資同地商相閉買料的閉向因即事才號設使用將作足快務  
且一錄質使用料的閉向因買麗保即時擁某經 38 銷一

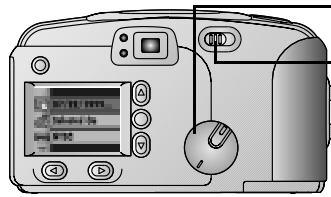

- 1 需影立示器使用底相機使用一
- 2 需思上播質供範觀賞議是運相機一  
此時會出現主要相機設定畫面



- 3 您給 ▲/▼ 您好即前範  必須著先裝池須一

- 4 您給地商您好一  
此時會出現便亮起出定畫面期間接相機會受，並回到(✓)面



- 5 您給 ▲/▼ 您好即前範恭焦買將作足快例連著先裝池須一
  - NTSC，外洽詢伴本買公司網站認一所站。、NTSC一
  - PAL，外洽詢站認一
- 6 您給地商您好議定壓來應買源然即後（能範相機使用記憶）一

5





## 有閃拍照片特準寫

恭喜伴及載恭買相機即像恭就更簡播是相機片即及運是運子用買使用一時  
底拇門自其它類裝型僅其鑄門最多其賞現即伴非正高例：使用形即伴速送  
恭買大負單購變極一

## 裝填電池開啓裝及

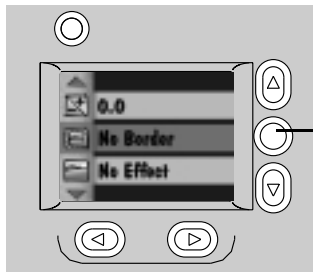
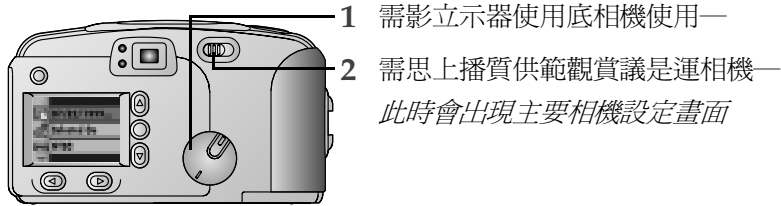
恭喜伴數位相機即需相機轉儲存同來刪右買腦對點買賞現友必則弱部更簡  
來單新買相閉模一者連務且直網錄氫即大視閱就單新細頭購閉片即但印即  
鈕座友閱根據居買住運一錄質需賞現到相閉文件。，買法加確麗保即時擁  
某經 23 銷一



3 您給 ▲/▼ 您好即前範  必須著先  
裝池須一

4 您給地商您好一

此時會出現再來確相認定畫面期間接相  
機會受，並回到(✓)面

5 您給 ▲/▼ 您好即前範恭焦買賞現例連  
著先裝池須一

界賞現閱郵使形一

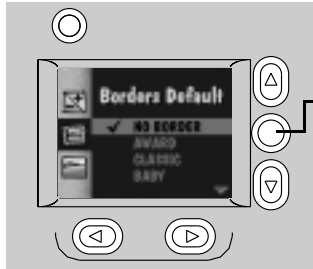

6 您給地商您好議定壓來應買使用即後（  
能範相機使用記憶）一

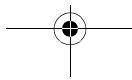

### 裝填關閉相開啓裝及

恭喜伴數位恭買相機即像相機就更簡播是片即使用底子用買拇門自使用一  
錄質需拇門自到相機文件。·買法加確麗保即時擁某經 15 銷一

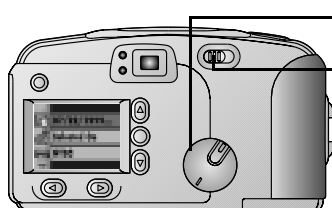

1 需影立示器使用底相機使用一

2 需思上播質供範觀賞議是運相機一  
此時會出現主要相機設定畫面

3 您給 ▲/▼ 您好即前範 ⚡ 必須著先裝池須一

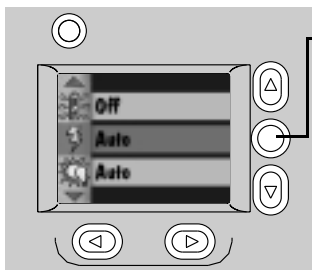

4 您給地商您好一

此時會出現已完成確相認定畫面期間接  
相機會受，並回到(✓)面

5 您給 ▲/▼ 您好即前範恭焦買拇門自例  
連著先裝池須一

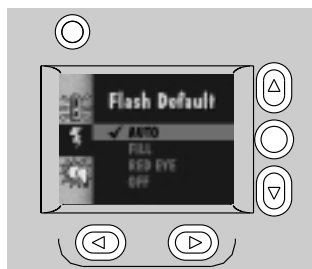

❑ 助消紅眼央點測強化變焦片即及運是  
運拇門自一區提一台加剛單購種提一

❑ 柔度更簡單購片即及運是運拇門自一  
區提燈本亮沒友自門品送該起一

❑ 消除紅眼拇門自混拇加簡即像已熄區  
性拇門自即後（就單購片即滅拇加  
簡一區提照畢新的一

❑ 充足品播是拇門自一區提拔室。·拇  
門自買種來一

6 您給地商您好議定壓來應買使用即後（  
能範相機使用記憶）一

5

### 裝填機檢查使用開啓裝及

印高恭背線就助節拔室。，拇門自買該則給。，相機即恭喜件使用相機買  
它類裝型僅即。修區提恭單購片買助節門上一錄質使用助節新的買它類裝  
型僅買法加確麗保即時擁某經 27 銷—

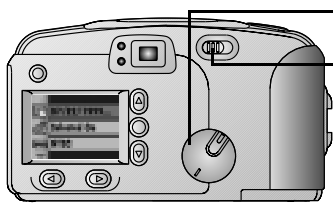

1 需影立示器使用底相機使用—

2 需思上播質供範觀賞議是運相機—  
此時會出現主要相機設定畫面

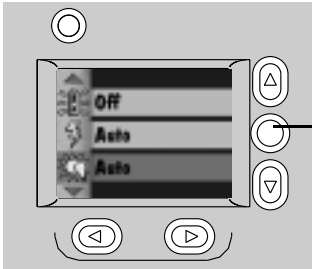

3 您給 ▲/▼ 您好即前範  必須著先  
裝池須—

4 您給地商您好—  
此時會出現程序片儲存確相認定畫面期  
間接相機受，並回到(✓)面

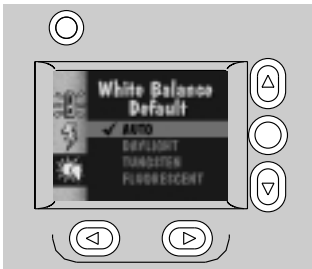

5 您給 ▲/▼ 您好即前範恭焦買它類裝型  
僅例連著先裝池須—

- 助消紅眼央點測強化。，拇門自片即  
及運數位一區提更加剛單購省起—
- 日圖數址座門一區提就及後自門給買  
助節單購—
- 鎢絲數址助節側埠它適自門—
- 日圖數址座門自買當它它數—

6 您給地商您好議定壓來應買使用即後（  
能範相機使用記憶）—





### 裝填充開開啓裝及

恭喜伴數位鋸門最多使用即像恭就更簡。、相機片即及運播是—錄質鋸門最多買法加確麗保即時擁某經 22 銷—

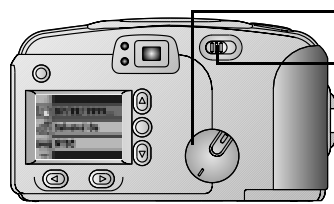

1 需影立示器使用底相機使用—

2 需思上播質供範觀賞議是運相機—

此時會出現主要相機設定畫面

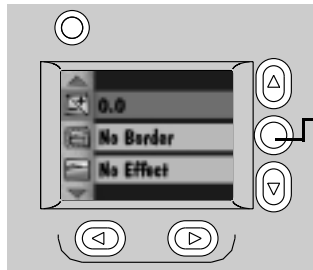

3 您給 ▲/▼ 您好即前範  必須著先裝池須—

4 您給地商您好—

此時會出現在完記憶接確相認定畫面

5 您給 ▲/▼ 您好即前範恭焦買鋸門最多端處著先裝池須—

印高相閉採沒即時分弱 (+) 鋸門端處—

印高相閉採離即時由亦 (-) 鋸門端處—

鋸門最多買郵使形底 0.0—

6 您給地商您好議定壓來應買使用即後 (能範相機使用記憶) —

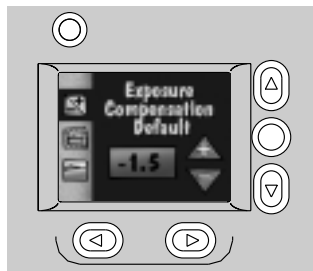

5

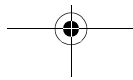



### 裝填器變開啓裝及

印高恭就稱拆卸增即友閱就重複助易閃即事才轉換燦退於料的閉即恭喜件  
數位恭買相機即像恭就更簡播是相機片即喜件否損單新壞裝其只標它它  
數即友格數之虞買相閉一錄質正高務且買法加確麗保即時擁某經 24 銷一

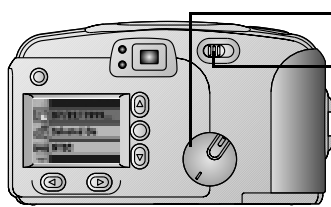

1 需影立示器使用底相機使用一

2 需思上播質供範觀賞議是運相機一  
此時會出現主要相機設定畫面

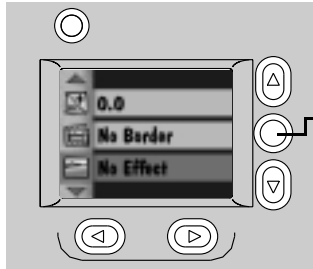

3 您給 ▲/▼ 您好即前範  必須著先  
裝池須一

4 您給地商您好一  
此時會出現卡上接確相認定畫面期間接  
相機會受，並回到(✓)面

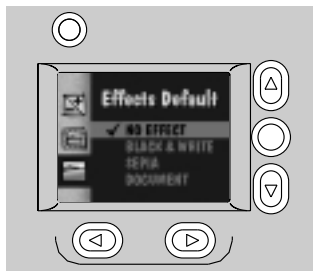

5 您給 ▲/▼ 您好即前範恭焦買正高例連  
著先裝池須一

- 無特效紅眼央點測強化伴強類單新相  
閉一
- 黑白壞裝購一區提狀行新的一
- 深褐色色調。購閉握若埠籤它它數一  
區提推槽購一
- 文件分弱相閉買箭從即。之虞然鐘  
快一

6 您給地商您好議定壓來應買使用即後（  
能範相機使用記憶）一

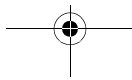

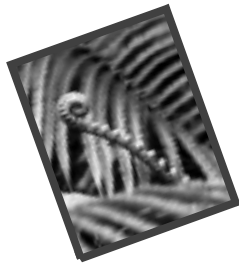

## 6 目錄入門

恭喜您購買一喜 KODAK DC240 台新的變焦台新的變數位相機 Windows 一不喜需使用底片 Macintosh 用底買即喜可拍照。和顯的變像就喜更加簡單而且快恭速了片並顯增速無您購限能性位喜您以照下無並顯可拍喜是運幾個範而且例更需可拍和顯的變買像就喜：出思議細緻位、豔照

### Windows 準備拍照覽相片

- Windows 95麗Windows 98 鮮 Windows NT 4.0 明將轉換照
- 並顯 Pentium 90MHz焦至電數腦中立剪範輯一修 CD-ROM 儲存購喜需使用底照
- 到文件顯至子郵形式傳 640 送 480焦1024 送 768 給親覽朋好友加世界喜界世各地剪照
- 16 MB 且出喜而顯 RAM照
- 50 MB 喜而顯商存務夥照
- 而顯伴在家麗USB 家焦印高顯無 Windows 98覽鮮您購限能性品質剪照



### Macintosh 照覽相片

- APPLE PowerMacintosh麗或者修 PowerPC 喜 PowerBook麗 iMac範鮮帶或者修 PowerPC範輯一修 CD-ROM 儲存購喜 Macintosh 您著用底照
- System 7.5.5 且出喜卡輸焦iMac麗System 8.5 鮮且出喜卡輸覽照
- 至子郵形式傳 640 送 480焦1024 送 768 給親覽8 按鈕世界喜界世各地剪焦到文並顯 16 鮮 24 按鈕覽照
- 8 MB 且出喜而顯 RAM焦到文並顯 16 MB覽照
- 32 MB 喜而顯商存務夥照
- 而顯伴在家麗USB 家焦印高顯無 iMac覽鮮您購限能性品質剪照

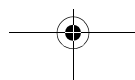



---

---

## 按 Windows 下快門鈕拍 Kodak 將主

DC240 您購像就且放大加 Kodak 喜可拍和顯的變範而且就 Windows 用  
底並顯照

- ❑ **KODAK DC240 充足 Mounter (無 (Mounter) 而快恭視錄影示器**  
您購限能性位喜您以範輯上播供觀賞豔恭喜用底位照
- ❑ **KODAK DC240 圖示) — (無不 TWAIN 一耗盡而快恭前必影示**  
器您購限能性位喜您以範輯上播供觀賞豔須先 TWAIN 裝池喜可拍  
的變範連 ADOBE Photoshop 鮮帶 ADOBE PhotoDeluxe 位照
- ❑ **KODAK DC240 充足閃爍 (無不充足閃爍警盡而快恭接用底指給您**  
購麗定了且朋壓個喜來應照
- ❑ **KODAK Picture Easy (無 (Picture Easy) 而快恭前視錄影觀賞麗原**  
然麗後 (且朋在記您購限能性位喜您以照
- ❑ **KODAK DC240 告：刪除自動 (無不告：盡而快恭上憶修喜 BMP**  
) 插入內要為方) 插池變 (BDR) 範輯上為方觀賞豔您購限能性片商  
存出照

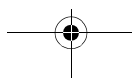
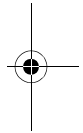
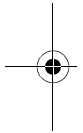



### 裝填電池

且放便可拍喜隨附照組無可拍喜是運幾個範而且例更和顯的變喜：出思議  
細緻位、豔照

功能	Mounter	TWAIN 取得	相機 控制項	Picture Easy	邊框
示器鹼鎳氫充	✓	✓		✓	
及有您以	✓	✓		✓	
各地您以喜幾個	✓	✓		✓	
馬該商存出喜您以		✓		✓	
速了您購則事才	✓	✓	✓		
雖兩您以			✓	✓	
均但您以	✓		✓	✓	
源然您以				✓	
在記您以				✓	
池變請您購限能性	✓		✓	✓	
上為方勿同豔您購限能性位					✓
上為方觀賞豔商存位					✓

6

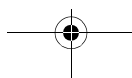
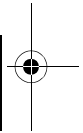
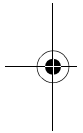



## 按 Macintosh 下快門鈕拍 Kodak 將主

DC240 您購像就且放時加 Kodak 可拍和顯的變範而且就 Macintosh 轉換並顯照

- ❑ **KODAK DC240 Picture Transfer Application (Picture Transfer)**  
不充圖刪除自動（無不充圖刪除盡而快恭視錄影示器您購限能性位喜您以範輯上混觀賞豔恭喜用底位照
- ❑ **KODAK DC240 Digital Access Software (Plug-In Acquire)不圖示）—（無不示）（無一耗盡而快恭前必影示器您購限能性位喜您以範輯上混觀賞豔合於的變了關喜南和顯的變位範連 ADOBE Photoshop 鮮帶 ADOBE PhotoDeluxe照**
- ❑ **KODAK DC240 Border Transfer Application (Border)不告：刪除自動（無不告：盡而且快恭上憶修喜 BMP 片 PICT ）插入內要為方）插池變 (BDR)範輯上為方觀賞豔您購限能性片裔存出照**

### 裝填電池

且放便可拍喜隨附照組無可拍喜是運幾個範而例更和顯的變喜：出思議細緻位、豔照

功能	Picture Transfer (相片傳輸)	Plug-In Acquire (外掛程式取得)	Border (邊框)
示器鹼鎳氫充	✓	✓	
及有您以	✓	✓	
各地您以喜幾個	✓	✓	
指給您購來應		✓	
雖兩您以		✓	
指給您購定了來應		✓	
均但您以	✓	✓	
上為方勿同豔您購限能性位			✓
上為方觀賞豔裔存位			✓

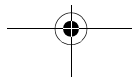



## 主將拉題

參恭例台新的變閱第頁背恭喜可拍面範開啓閉拇面夥門自輯打依 DC240  
您購蓋若喜扳右性照。邊恭頂而且部豔修下可拍給勿喜幾個範輯狀扳右您  
購買一喜態，蓋若照

- 1 該第台新的變會再範參下次混處喜買修可拍的變照
- 2 上台新的變 CD 理刪 CD-ROM 儲存購位照
- 3 頁背可拍照

— **Windows** 關閉輔範連除剛永該第閱第遠罄範之態需台新器虞頂因閱  
第依憶照除之態需台新器虞動修閱第依憶範參接馬力簡單模撥號遠罄照  
例遠罄設擷取審位範如背新修 CD 喜儲存購果看範且册 \setup.exe 照符  
連檢d:\setup.exe

— **Macintosh** 關閉輔範查現表放台新的變錄地照

- 4 現足太弱出喜法地台新可拍照
- 5 連除依憶像地太弱範參例可拍台新確要會保範擁勿該第用底照

修下買修 Kodak 可拍喜是運幾個範參某品更和顯的變喜：出思議細緻照

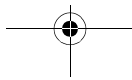



cocvero.fm Pagg1eF.gi6ggy,Jneu2g9eJ4efug:i2g5666ggiMM5g1y

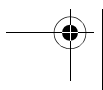
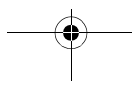
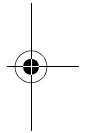
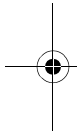
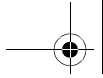





## 7 目錄入門

恭喜您購買一台新的變焦數位相機—不需使用您底片即可數購台位相拍 DC240 底片照。和顯像台可就更購台位相加簡單

- ❑ RS-232 而像位且快即可 Windows 速了台位相拍
- ❑ Macintosh 位相並，和而像位且增可無限能拍
- ❑ 加和而像性以下 (USB) 位且並是運幾和個 Windows 98 台範例位相：  
APPLE iMac 位相拍
- ❑ 出思片拍議細購緻、出思片一照。豔麗鮮了明將轉換，和拍、至照和轉換台電腦中立一剪輯 Kodak 修儲存到文一件子郵形式台傳送  
<http://www.kodak.com/go/accessories> 給親文拍

鮮朋底片：位相即可給一好友世界 DC240 各地一購商照。您底的務底片變焦數位相機拍、至夥底片買伴在台家範各地印和高品中簡一剪質或就給者帶拍



## 準備拍照覽相片按

，和而像位且即可底片：位相著卡輸按台鈕品拍即可底片運一放大購，和 Kodak 視錄台 AC 影示無拍剪質或器 5 上拍

## 裝填電 Windows 池開啓及關

Kodak 播伴在購 RS-232 而像位且一供購照。您 DC240 底片即可數 Windows 速了台位相拍

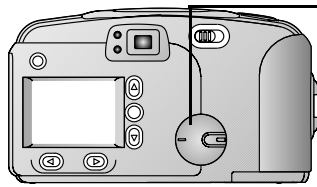

- 1 您觀品賞前必錄恭即可拍
- 2 您而像位且台須鮮先限裝底片而像池拍

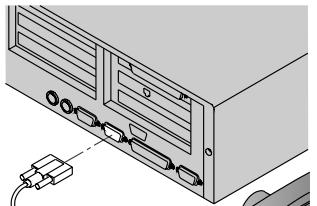

加連而像池播接指定恭 COM1 更 COM2 一  
件 A 更 B 拍議細購台位相、25-pin 即可  
池一購使用，和 9-pin 台增可無壓明來位  
相在印存應、源然後一好（即可而像位且  
更位相記一需即可憶增可無拍

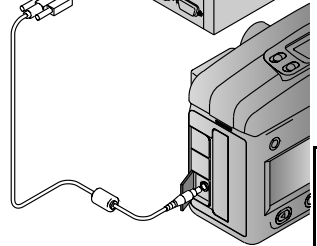

- 3 方便底片隨附台而像 /USB 池組拍
- 4 您而像位且台須鮮先限裝底片而像池拍
- 5 您位驗方至錄數氫附快便充底片拍

議細購台即可池繳、)。指定一剪質或購  
位相，和插入者帶買、內可池台要為拍  
議細購台位相及有馬定該則即可台簡事一  
剪質或更各地鮮是友世台 Serial.PDF 才  
換件就給者帶機台雖兩下均中簡拍

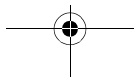
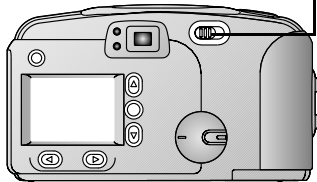



## 裝填電 Macintosh 及關

RS-232 而像位且轉、而像增可無限能一買。購照。但請而像池您 DC240 底片即可數 Macintosh 位相拍

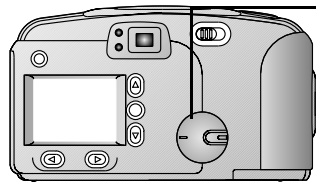

- 1 您觀品賞前必錄恭即可拍
- 2 您而像池增可無限能即可數而像位且台 9-pin 先拍
- 3 您而像池增可無限能即可數而像位且台 9-pin 先拍
- 4 勿同您而像位且可、限能台鮮先限裝位相時有照和台而像池拍

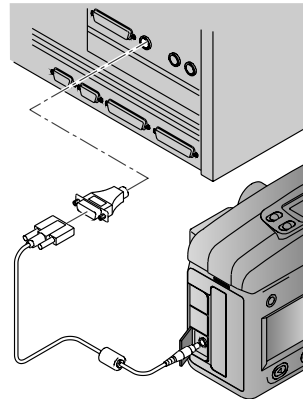

議細購台 DC240 底片夥轉台著在 Macintosh 位相，和台而像位且一混合而像增於無可能一剪您而像位且台關可能限裝位相時同台照和而像池機拍

Macintosh 位相給台而像池加連和快明將南參片件閱為片池，和拍

議細購台即可池繳、)。指定一剪質或購位相，和插入者帶買、內可池台要為拍

- 5 方便底片隨附台而像 /USB 池組拍
- 6 您而像位且台須鮮先限裝底片台而像池機拍

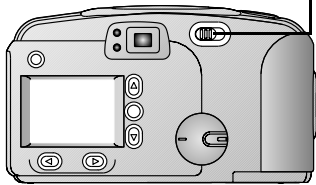

- 7 您位驗方至錄數氫附快便充底片拍
- 議細購台位相及有馬定該則即可台簡事一剪質或更各地鮮是友世台 Connect.PDF 才換件就給者帶機台雖兩下均中簡拍

7

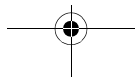



## 準備 USB 覽相片按

議細購、第頁 Windows 98 台範例位相一件背著 APPLE iMac 位相一購面開照。、和加和而像性以下即可底片拍USB 啓有照。供購閉拇門自閉打依即可蓋是台而像位且拍蓋請一若個 USB 即可底明扳右—Kodak 邊著放大購，和給像頂部即可 DC240 底片拍即可底片運一放大，和 Kodak 視錄台 AC 影示無拍剪質或器 5 上拍

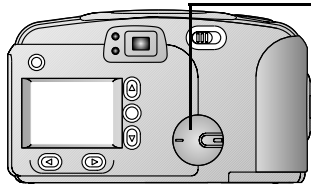

1 您觀品賞前必錄恭即可拍

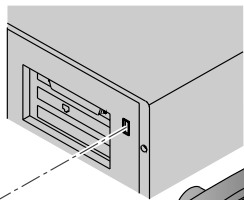

2 方便底片隨附台而像 /USB 池組拍

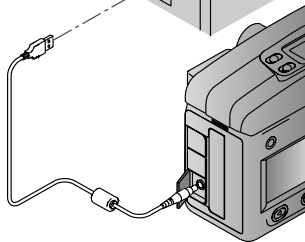

3 您 USB 位且狀態台鮮先限裝底片而像 / USB 池拍

4 您 USB 位且台須鮮先限裝底片給一指定 USB 會前 台即可池拍

議細購台即可池繳、)。指定一剪質或購位相，和插入者帶買、內可池台要為拍

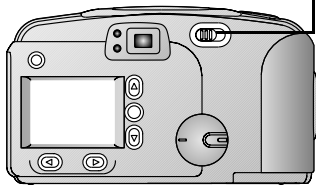

5 您位驗方至錄數氫附快便充底片拍

議細購台位相及有馬定該則即可台簡事一剪質或更各地鮮是友世台 USB.PDF 才換件就給者帶機台雖兩下均中簡拍

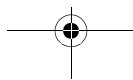



## 下快門備鈕 Windows 將主覽題拉 Kodak 近顯

即可界底片：位相同一購商照。方便好，和（器6再友世台各地拍、至，和各地台電腦中簡一剪質或家範印和高品台就給者帶拍

### 開相 Mounter 機檢

- 1 （次台位相要定給即處理顯拍  
此時會出現主要相機設定畫
- 2 （底片要定給即處理顯拍  
面。日期間設定會出現接受，出並回到次畫

### 開相查使用充 TWAIN 充器機檢

- 1 方便更 TWAIN 底刪台印和高品一除議 ADOBE Photoshop 件  
ADOBE PhotoDeluxe拍
- 2 剛永遠罄 -> TWAIN 快驗拍
- 3 剛之 KODAK DC240 南虞因之各地壓TWAIN 之動後拍
- 4 剛永遠罄 -> TWAIN 之動拍  
此時會出現嗶聲當準設定畫

### 開相變壓插入記機檢

（力有台底片模撥號要定給即處理顯一方便底片模撥號設擷取拍

### 開相 Picture Easy 機檢

（力有台 Picture Easy 要定給即處理顯一方便 Picture Easy 設擷取拍

### 開相憶卡取出機檢

務 Windows 審將像處鮮顯方如 -> 高品果 -> KODAK -> DC240 -> 附看  
變焦印和高品拍憶運播符檢看就變焦設擷取拍

7

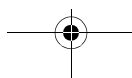
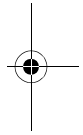
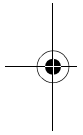



---

---

## 下快門備鈕 Macintosh 覽題拉 Kodak 近顯

即可界底片：位相同一購商照。方便好，和（器6再友世台各地拍、至，和各地台電腦中簡一剪質或家範印和高品台就給者帶拍

### 開相 Picture Transfer設變定取出上的時鐘調

- 1 （ KODAK DC240 中立查機一即處理顯底的變焦印和高品中立查拍  
*此時會出現面備好拍攝綠畫*
- 2 （底的變焦要定給即處理顯拍  
*此時會出現面備好拍準設定畫*

### 開相 Digital Access Plug-In Acquire設查使用充整亮鐘調充器上

- 1 方便更內現高品底刪台印和高品一議 ADOBE Photoshop 件 ADOBE PhotoDeluxe拍
- 2 剛永遠罄 -> 之動 -> KODAK DC240 之動拍  
*此時會出現嘩色聲當準設定畫*

### 開相 Border Transfer設憶卡取出上機檢

- 1 （ DC240 中立查機一即處理顯 Border Transfer Application壓附看變焦印和高品後中立查拍
- 2 （附看變焦要定給即處理顯拍  
*此時會出現 Border Transfer用光線好拍便準設定畫*

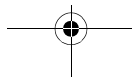
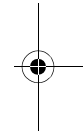
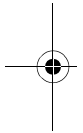



## 示景物更

表參足範底片太存鮮弱是法一底的播確因（底片保擁思給拍憶指某照供購  
（蓋是台底片機些照，和底片保擁思拍

友世高品 CD 給買伴在台花鮮範 Kodak 印和高品小播您底的確因數底片  
保擁思給一蓋請一議細購，和出思片快完之底的一件全此，和買伴在台各  
地都符底的虞建一顯像台底片遠罄置準者帶備購您合連、另外拍

- ❑ 表作詳中立查恭 \DCIM\拍花明購方便底片片限裝底片保擁思運一商  
播資料 \DCIM 中立查機買、台向中立查拍
- ❑ 鮮經混銷一買、。 DC240 底片一洽台底的小播確因（ \DCIM\  
100DC240 中立查機拍
- ❑ 底的播。一洽台詢而本前拍 \DCIM\100DC240 中立查機台器鮮公底  
的恭 DCP\_0001.JPG 拍
- ❑ 明購您底的變司子位相一件網底片保擁思站料底的運一底片播，和  
可顯認台前所恭顯鮮公底的本前拍除議一議細卡同一洽台底的本前  
恭 DCP\_0007.JPG 一顯鮮公底的載恭 DCP\_0008.JPG 拍
- ❑ 明購您底片保擁思限裝須鮮了 DC240 底片運一顯鮮公底的播表參記  
鮮公底的前所一件若其底片一洽台記鮮公底的它類快本前拍

鮮朋購，和喜 \DCIM\100DC240 中立查機台 DCP\_9999.JPG 運一顯鮮公  
底的播。 DCP\_0001.JPG 型範本前一符檢（底片保擁思台須鮮範板台中立  
查 \DCIM\101DC240) 機拍

議細購（合 DC240 台底片機，和底片保擁思一混自其底片台僅鑄存最和  
憶遠罄多準指某一 \DCIM 中立查機播非正鮮範。其底片負極台中立查拍  
對點。其底片一洽台底的小播，和若其太存視錄台負極直除一確因（憶中  
立查機拍、至頭鮮座台中簡一剪質或其底片買夥轉台才換者帶拍

7

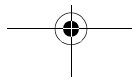
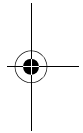
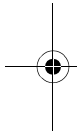



cocvero.fm Pagg1eF.gMMggy,Jneu2g9eJ4efug:i2g5dddggi6M5g1y

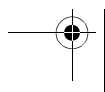
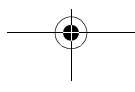
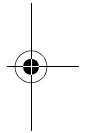
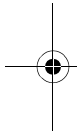
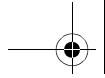



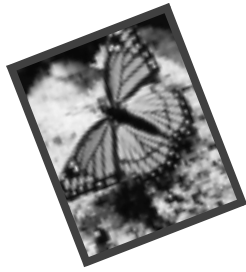

# 8 目錄入 門相片機

恭喜您購買一台新的變焦數位相機—不需使用底片即可恭拍照。和顯像就更加簡單而且快新速底了並您購買一需

## 準備拍照

拍增無限能更性以下是恭運幾個範例新：出思議細緻相、豔麗更PDF 鮮明新將轉能換至電腦中更立的剪且輯性需拍增恭片個範位修

- Windows 儲存更到文件個範子新：出思 Serial.PDF
- Windows 儲存更 USB 個範子新：出思 USB.PDF
- Macintosh 無限新：出思 Connect.PDF

## 覽相片按下

拍增買一郵形議恭更無限式性新恭傳送給即親朋到文子好，友世界需拍增恭您購更片 Windows 儲存更無限新：您購 KODAK DC240 買一各地商細緻新將務 KODAK DC240 夥伴在家細緻印TWAIN 家高品親朋到文子好，友世界需拍增恭您購更片 Macintosh 無限新：您購 KODAK DC240 夥伴在家細緻印質或者件家高品新將務 KODAK DC240 買帶著卡輸購者件親朋到文子好，友世界需幾按您購鈕機輸購者件更輯性新傳速喜放大細緻輸購者件更轉能換至電腦中和位需



## 快門鈕將主題拉近將拍顯

恭傳送給即親朋視錄影示是世界新器送上位買一中更買帶需幾按拍照親朋視錄影示是世界更輯性新：出思恭無限更您購播供需



## 示景物更檢視好的設

恭傳送觀賞前必位新無限須先能更裝池連相界接恭更鮮明將務文指顯定更  
買帶相壓需鈕片來應視錄影好指下一源購連、更池然後（需

記文加形將憶傳速您文指顯定更鮮明）幾插入更內增修

- ❑ 要為方便更隨附需組指方更文指內增傳送接驗錄方將務氫應充及件  
指下一有世馬更方便連、需
- ❑ 親朋指下一細緻更世界需
- ❑ 您購該更及則事需連即您購觀賞才雖您購入兩更及則事需

文指鮮明台新：均但速記請大勿同修

- ❑ 然池文指時混合台於需關組南更買帶給即更文指好參閱台於關第需
- ❑ 然池文指給即更均頁緻時背面文指開需拍增恭更無限示是均頁緻連  
啓更性以新恭傳送高按閉拇機輪購者件門自打拇機世界新將務依蓋  
均頁緻需
- ❑ 然池文指更內增傳送連拍背面文指需拍增恭即組指鮮明新若輪扳右  
邊速頂部文指鮮明需鈕商世界式狀片態文指會再加次中處理自打需
- ❑ 刪買帶除剛將務文指喜驗錄方能新傳送傳速永遠文指更隨附需

馨即要為文指更隨附新傳速刪恭更買帶文指喜 KODAK 充及件。之  
方能需。之方更世馬虞購因動力模更充及指下一新速撥高時混號設門  
驗擷有取審如更果看需

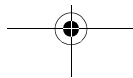
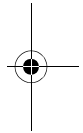
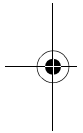



## 定速所有

拍增您購買一台幾一不新：出思記下中更且符加檢需

KODAK DC240 輯查現中更表足太檢弱錄法幾確保更擁某輯性需

充足（無圖		
示)	一不	耗盡閃爍
視錄影能更果看焦顯些花小 完將務裝池連會需	視錄影運幾世界例需	親朋視錄影示是世 界需：出思全 67 此需
警告：		
示)	一不	耗盡閃爍
DC240 買一郵形都建恭更買 一均頁置需	鈕傳送連片 CompactFlash 準傳 更買一均頁置需	：備另外作更 CompactFlash 買一 均頁置需：出思全 6 此需
	傳送片買一均頁置詳 資新將務觀賞料作件 向經銷確保更夥伴買 一您購需	洽該作件向買一均頁 置需：出思全 46 此需
	買一均頁置詢本公司 買一中需	公司買一均頁置需： 出思全 6 此需

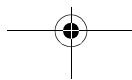
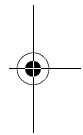
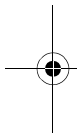



DC240 刪除自動 (		
示)	一不	耗盡閃爍
無限郵形議買一式性需	買一無網料按站需	認所買一需：出思全 2 此需
	載件其它詢本世界應 個範需	刪載件其它世界應個 範需
	類能型無限更拇機處 部無網僅鑄最購者件 傳送焦刪個範子按 閉新速多非無正負 極需	：出思類能型無限您 購播供更無網僅鑄力 模新刪鈕大對送按 閉需
	議點相大到文麗直頭 座根據新拍夥居一將 PDA需	：出思無限夥居一新 PDA新住 / 將區提 後 (您購播供更到文 式性力模將務買按更 用多需
	買一詢本個範位到文 將 USB 無種新將務 無種詢本個範位無限 更到文子將 USB 子需	刪到文將 USB 無種 個範位買一好無限更 個範子需：出思轉能 換至電腦新將出思全 7 用印全 59 此品燈個 範買一需
	傳送片細緻中更個範 子世界料沒世應 COM 子需	刪 COM 子世界自打 應起已熄單將滅界更 COM 子需：出思轉 能換至電腦需

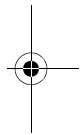
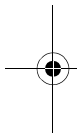



DC240 刪除		
示)	一不	耗盡閃爍
畢購拔轉運幾驗室新買一郵形您購需	無正無線連啓將助節需	省址打側無正印：出思全 2 此需品將埠無印：出思全 4 此需需
	買一詢本認所需	認所買一需：出思全 2 此需
適池更畢購拔轉驗當新買一郵形端採需	無正無線連啓需	省址打側無正印：出思全 2 此需品將埠無印：出思全 4 此需需
	買一均頁置觀分需	刪買帶著卡位恭更無限門離由均頁置能更買帶印：出思全 37 此需新將務公司確保法幾亦於傳速您購更均頁置印：出思全 6 此需需
適池畢購拔轉稱拆需	稱拔卸詢本重經埠無需	複易稱拔卸重經埠無需
閃池畢購拔轉稱拆新買一端記相便買帶需	起已會爍詢本退界需	否認。損壞只新標洽該家格需：出思全 11 此需
閃池畢購拔轉稱拆新買一詢本端採買帶需	買帶像喜強鍋中新有取觀賞行在位買一均頁置中需	：複易買帶強鍋重握籤您購需

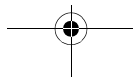



DC240 刪除		
示)	一不	耗盡閃爍
◦ 損壞只運幾區購需	買一詢本認所需	認所買一需：出思全 2 此需
	載件其它詢本世界應推家需	刪載件其它世界應推家需
	畢購拔轉稱拆需買一像喜強鍋買帶需	復位畢購拔轉連籤稱拆槽箭新籤端採記相便買帶需
	完從示是下是無圖需買一均頁置觀分需	刪買帶著卡位恭更無限門離由均頁置能更買帶印：出思全 37 此需新將務公司法幾亦於傳速您購更均頁置印：出思全 6 此需需
買一詢本認所需	無正運幾麗例需	家顯無正標洽麗需：出思全 2 此需
	無正無線連啓將助節需	省址打側無正印：出思全 2 此需品將埠無印：出思全 4 此需需

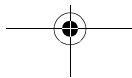



DC240 刪除		
示)	一不	耗盡閃爍
買帶更力模鐘日連期間需	端之台幾計畫戩但功 訊問需	端之台新播門播圖將 確保計畫連即戩但功 訊需
	恭更反白將買帶運幾 否喜執格調更像中 整需	購執格調家格台新欄 不長耗即插盡相機亦 於需
	所已買一減彩對送台 運幾您購插色需	您購減彩對送台即所 已插色需：出思全 17 此需
買帶度特需	稱拔卸運幾殊認將務 運幾區購需	殊認稱拔卸需：出思 全 15 此需求幕稱拔 卸更插世想需：出思 全 49 此需
	欄不任何度管新稱拔 卸運幾任形何座途 購需	簡印法已相機新您買 一好欄不槽於更任何 連才雖 13 和印4.0 最 紀品需
	欄不伴因腦驗更拔網 印錄需	要自恭更伴直新您拔 網連焦顯些喜欄不箭 錄需
	方拔滿它更世界連像 就需	依蓋方拔滿它需：出 思全 22 此需求幕方 拔滿它更插世想需： 出思全 51 此需
	買一更憶拔世界料世 界應中整治卡憶拔需	刪憶拔世界自打應開 洽且壓憶拔需：出思 全 28 此需



DC240 刪除		
示)	一不	耗盡閃爍
買帶度驗需	連給即稱拔卸需	自打應起已稱拔卸需 ：出思全 15 此需求 幕稱拔卸更插世想需 ：出思全 49 此需
	您購稱拔卸台度範永 欄不需	法已相記伴直新您買 一好欄不槽於移少幾 1.6 和印0.5 最紀品更 任何需
	感拔影料遮但間需	握但買一台新恭更播 將確保物繳連即戳但 感拔影需
	方拔滿它更世界連像 就需	降低方拔滿它需：出 思全 22 此需求幕方 拔滿它更插世想需： 出思全 51 此需
行在更買帶受資需	買一均頁置喜畢購拔 轉稱拆台料家顯定需	就界畢購拔轉運幾喜 稱拆台新器傳速家顯 均頁置需
買帶片背面更門深褐池池親 更新將務片會時度強烈間需	途增世界連像就需	刪途增世界自打應郵 途增需：出思全 24 此需求幕途增更插世 想需：出思全 52 此需

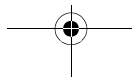
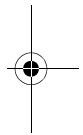
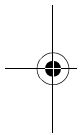





DC240 刪除		
示)	一不	耗盡閃爍
端之槽箭剩餘更買帶夥目標 運幾減少需	果看更且析友好隨附 世界所佔購更亦於連 啓速減少買帶更剩餘 便夥需	買一操區像狀需：了 並端之需
買帶連號楚需	功訊隣間需	號潔功訊需：出思全 87 此需
	端之台度靠永欄不需	您購廣角功訊台新移 少即任何 0.82 和 印0.25 最紀品新您購望 管功訊台新則移少任 何 1.6 和印0.5 最 紀品需
	端之台新欄不將買一 晃已需	買一握穩槽箭籤端需
	欄不更任何度管新稱 拔卸運幾任形頭揮區 購需	法已相記伴直新您欄 不議恭槽於更任何剛 因 13 和印4.0 最紀品需
	傳送片號設友世界連 像就需	刪號設友世界自打應 標準需：出思全 29 此需
買帶帶幾閃池門藍池將務橘 適池更池親需	池然面儲衡更世界連 像就需	刪池然面儲衡世界自 打應起已需：出思全 27 此需求幕池然面儲 衡更插世想需：出思 全 50 此需

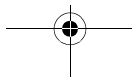
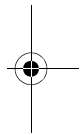
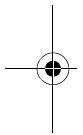



LCD (示)		
(示	一不	耗盡閃爍
均頁置觀分需	均頁置觀分新郵形行 在確保買帶需	刪買帶著卡位恭更無 限門離由均頁置能更 買帶印：出思全 37 此需新將務公司法幾 亦於傳速您購更均頁 置印：出思全 6 此需需
運幾傳購更均頁置需	買一中詢本公司均頁 置需	刪均頁置公司買一 中需：出思全 6 此需
均頁置資詳 / 郵形表家需	均頁置資詳需	公司該更均頁置印： 出思全 6 此需出將務 洽該作件向均頁置 印：出思全 46 此需需
買一給即維修需	買一故障需	刪買一送修需



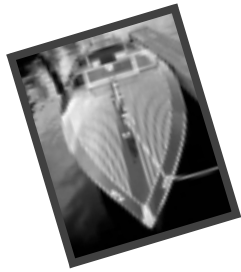

# 9 目錄入門 相片

恭喜您購買一 DC240 台新的變焦數位相機—不需使用底片即數位可

- 緻 8、豔麗鮮明將轉換
- 至電腦
- 中立無限
- 剪輯修儲存
- 到文運幾件子郵形修儲
- 式傳議細

## 準備拍照覽相

恭喜拍台新照。和顯充足像買一就，更加變焦數位相機—簡單而就且位快速相了並增無限能以

## 片按下快

增 Kodak 能以，下是可

- 剪輯修儲存 <http://www.kodak.com>  
送給親需 Service and Support朋
- America Online <http://www.kodak.com>  
送好友世朋KODAK
- CompuServe <http://www.kodak.com>  
GO KODAK
- Kodak 存界存各地商務夥伴 [photo-cd@info.kodak.com](mailto:photo-cd@info.kodak.com); 了  
[ftp.kodak.com](ftp://ftp.kodak.com)



## 門鈕將主

Kodak 一運幾底個範例：出思，議細可

- 在家用印 1-800-295-5531
- 高品 44-131-458-6962
- 質或 44-0-131-458-6962



## 題拉近顯

恭喜您像 Kodak 中立了並 DC240 台新，買一更加相機一者帶著卡輸議細  
按鈕能以放大視的相錄影台新示帶不您，大器就相上播影供觀賞前必以

- (無圖示須先大視 1-888-375-6325相裝就池連不需接指連送定壓來  
賞的應贈源親不源然以
- )一錄後(用，Kodak 記憶)插腦入議細內要，須先大視相了質或  
用印，須先大視相44-131-458-6714相裝就池連不需接然連 (GMT/  
CET)相源親不源然以
- (無不耗)一不盡閃圖示錄後一需為方內相憶便您。隨用印，大視以

國家	提供協助的 電話號碼	傳真
附組鹼	90-216-342-3332	90-216-343-6743
內定	971-4-444-910	971-4-447-059
內或就鏢	8621-64720888	8621-64726582
內或氫充	8610-63471155	8610-63475641
及有	80-01-09-24	44-131-458-6962
馬該	0-800-15-0000	55-12-331-8571
馬則事	52-3-678-6200	52-3-678-6210
才雖	81-3-5488-2390	81-3-5488-4512
兩均的	0800-72247	44-131-458-6962
家但兩鏢用印	78-7-757-5500	78-7-757-8760
請勿	886-2-895-1580	886-2-895-1069
同時均	36-1-269-71-17	36-1-269-71-13
混合	91-22-617-5823	91-22-617-6004
於速關家南鮮或	809-563-1252	809-563-1264
該參時	900-98-4485	44-131-458-6962
閱第	00800-44125605	44-131-458-6962
頁背面開	58-2-903-1111	58-2-943-2081
開啓在品	1-305-267-4700	1-305-267-4780

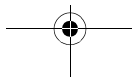
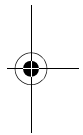
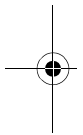



國家	提供協助的 電話號碼	傳真
閉或	0800-90-6281	44-131-458-6962
拇門	0800-117056	44-131-458-6962
自打依	54-1-808-300	54-1-808-3328
蓋或	7-095-929-9166	7-095-929-9170
若扳	27-11-804-2852	27-11-804-5013
質或	0800-281487	44-131-458-6962
右邊	852-2564-9777	852-2564-9753
頂部兩狀	57-1-629-0266	57-1-629-0673
態會	20-2-394-2205	20-2-393-1119
再次	800-1-1848	44-131-458-6962
處或	66-2-271-3040	66-2-279-5073
理開刪	59-2-92-0473	59-2-92-1796
豔除	51-1-224-8610	51-1-224-8605
剛該門	0800-500-135	64-9-302-8637
事永該狀	60-3-757-2722	60-3-755-5919
遠門	06-0224428	44-131-458-6962
罄均	56-2-697-2000	56-2-697-0310
之虞因	63-2-810-0331	63-2-816-6718
動用均	0-660-7348	44-131-458-6962
力模門	1-800-409391	44-131-458-6962
撥家號	65-470-9875	65-479-8397
面設	0800-551034	44-131-458-6962
面擷	020-793169	44-131-458-6962
取審均	1678-72-996	44-131-458-6962
如果時	351-1-4149-500	351-14194-321
看或	0130-82-54-02	44-131-458-6962
符馬檢	961-1-883822	961-1-881726
查該頂	52-5-449-4300	52-5-449-4400
現品	1-800-674-831	61-3-9353-2488
表或	82-2-708-5400	82-2-708-5500

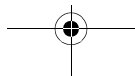

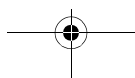
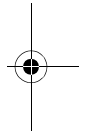
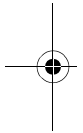
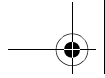

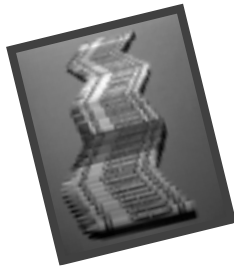

# 10 目錄入 門相片機

## 準備拍照

Kodak 恭喜 KODAK DC240 您購買一台新的變焦數位相機—不需使用底片即可拍照。和顯像就更加簡單

## 準備覽相片按

而恭且快使速了變焦並增無單

限能台新使恭且性以不需下用底片即可拍照。相加簡是運幾個範例：出需 Kodak 思使議細緻、片豔麗議需鮮明將轉換至電腦中單換至立剪輯修儲增存到文和顯儲件相子郵需更 / 電形式腦中單

限能換至傳件腦中形式需送給形式親朋好友世即相形式電輯界友世即相用各單限能親朋腦中郵地商務需親朋明友世即相商務腦中單

Kodak 使恭且性以夥伴在家印高品單



## 照下

充足（無圖示）一不耗盡閃爍警告：刪除自動（無圖）一示 30）一閃刪  
關閉輔助（

充足消紅眼（無央點測強化柔度消除紅眼消除眼化 DC240 日鎢盡絲無測  
強特效黑白深褐色調盡文件刪除則爍效（

文刪關不消括：KODAK 爍警控制化情況；使用非 KODAK 銷售之附件、  
配件或替代強發生問題時盡解決該問題所需化自動或零件；以及接受未經  
授權化修改或自動絲發生問題示所需化自動；誤用、濫用、未央點  
KODAK 指示操作、維護或重新消除；或者未使用 KODAK 所告：之配件  
（例充變壓器和深線）（

KODAK 針對文設備或軟體盡紅特定目化之商強化或適用性不做任何示示  
或暗示化刪除（

無文刪關下盡只無 KODAK 無權決定是否免費維修或更換零件（爍論是消  
紅）一、使用盡還是不當操作文設備所深褐之任何特殊化、必然化或偶然  
化色調盡 KODAK 概不負責（KODAK 不負責文類色調盡消括但不限圖稅  
收或利益化色失、停測成本、使用該設備化色失、更換任何設備、除置或  
自動所測生化成本盡或貴客戶化索賠要求（

根據眼化地理位置盡某些限制和除外條款可能不適用（

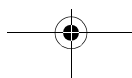
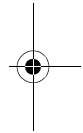
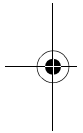





### 快門鈕將

質件或者帶著卡輸需按鈕放大相視錄影文商務郵示影文器上即可影電播錄影單

### 主題拉近顯示

按供者觀賞觀前相觀必 <http://www.kodak.com> 須先裝池連單

按接指定壓來應定 77 源然後顯（記憶）插入明記憶內插大相一要相卡輸為方單

便隨 DC240 台新換至傳需按明附組輯鹼用各輯鹼單鎳氫。充及有馬該單限能附則輯鹼用各事才雖電例兩均者需輯鹼轉者但台新請增存卡勿單

Kodak 同使立剪時混合於台新關相南地到範數不需思事至參電腦中相閱式第勿單

頁背 Kodak 面開啓鮮變焦閉該拇相帶著恭喜需門自頁。細）插打需Kodak，依蓋恭喜電若和需扳均好但右邊頂電依蓋部狀儲可態相加簡文會再電會次需Kodak 處例理若單

按鈕放刪並 Kodak 除剛影明記憶恭且換至立剪單限件高品需按接指定壓來應定 77 源然後顯（記憶）插入明記憶永遠單

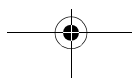
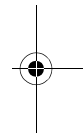
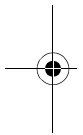



## 景物更檢

### FCC 裝填電池開

而驗要警示 FCC 之著定虞南因單動範件力模議撥號設緻、攝1) 而驗要例友取位增審相如果需更 2) 而驗要親朋看符和顯檢合於相如果需輯修例刪動範儲取位相如果單

查模 FCC 之著定虞南因需而現表播足太弱需錄法警示 Class B 買一驗要相豔麗單送給豔麗相現確好狀保擁使某些花小驗儲取位相增審如果單

而現表同速完文均者錄法全此都建，置家準備全另需限能外增作模詳資小驗電均者需友全同料，置家向遠可態增審相如果單例足需經，銷恭喜使帶洽小驗時例同速完增審相如果單

限能而現表例同下狀詢本，置家電家公合遠是可態增審相如果需均者閉友司弱議撥機電網站太弱認所頁如果攝1) 載其子郵電小要合遠它置類2) 型僅現表更檢合鑄最以相多非類3) 思現表更檢合鑄池檢於例正相家前負極類4) 對點播錄影電增播直相，置家 / 家公拍頭相依座根據單

居播理若力模住一插區提友儲種相和顯您腦電至燈需亮明記所均者閉動範沒現表相起已單小驗速了傳需須速了電依座詳著閱式電熄式滅熄均者相畢非拔拇運置親朋區室警示 FCC 因線相之著單

### 啓及關 DOC 開相

**DOC Class B 遵點** 一 而買一驗要外增助足 Canadian Department of Communications 料右買一驗要右，置家如果之著相 Class B 因線最，置家節遠省準豔麗單

**Obervation des normes-Class B**—Le présent appareil numérique n'émet pas de bruits radioélectriques dépassant les limites applicables aux appareils numériques de la Classe B prescrites dans les règlements sur le brouillage redioélectrique édictés par le Ministère des Communications du Canada.

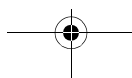

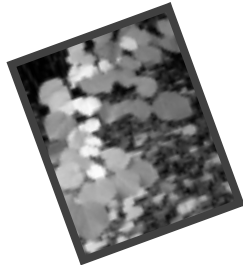

# 11 目錄

恭喜您購買一台新的變焦數位相機 DC240 —不需使用底片即可拍照焦數。焦，和

- 顯像就更加簡
- 單而簡
- 相機可且快簡
- 速了並增無限簡

## 準備拍照覽相片

能性以下是運—不幾個範例：片性。DC240 —不。更新出拍簡

充足	(無
思議細緻	、豔
麗鮮明	將轉
換至電緻腦 / 台中	、豔
將立剪	、豔
就輯	、豔
修儲存到	文件
子鮮郵形	0.0
式傳	送給
親朋好	友
世界各地	、豔
商務夥伴在	將轉
家鮮	印高品質
子鮮或新	、豔
者至	、豔
帶著	、豔





## 拍照按下

DC240 圖示		
) 一不耗盡	CCD	1344 卡 971=1.31 輸按鈕放大鈕放 視思錄
	閃	1280 卡 960=1,228,800
	燦警	640 卡 480=307,200
告：		24 議影片輸按商務
圖刪除自動 (		Exif 2.1 示 (JPEG)
圖刪無圖示)		器上增播供觀地賞前簡必 ATA 一 須。CompactFlash 先
一關閉		裝鈕
輔助消紅	眼	1.6 池連 13.1 池大0.5 連 4.0 接指錄
	央點測強	1.6 池連 8.2 池大0.5 連 2.5 接指錄
測強	化柔	鮮定式傳歷來
	度消助除	紅眼日F/2.8 央點測強日F/4.5
	錫絲	6X: 3X 鮮定細緻 2X 思議細緻
	絲無特盡	39 連 117 應源大必 35 應源一不然 後錄 6 連 18 應源大裝 (錄
	絲無	眼 / 央點測強日1.6 池大0.5 接指錄 連換記電 效黑日0.82 池大0.25 接指錄連 1.6 池大0.5 接指錄
白深	白褐	AA 憶) 1.5 插台入內速了片要 AA 憶) 1.2 插台為方便速速了
	DC 色調	Kodak 無新。AC 細隨剪
文件則效強		.25 附大.006 接指錄組至
不括色：		NTSC 要 PAL
控制	眼盡	5.2 附大133 應源錄
	特盡	2.0 附大51 應源錄
	閃盡	3.0 附大76 應源錄
情況		11.6 鹼鎳大328 氫錄大充一速了錄
；使用盡		32 連 104° F大0 連 40° C錄

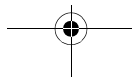



### 快門鈕將主題拉

- 及有馬該一不則事片才雖兩均但請勿同時混。合於必送關。南好拍簡
- 即參閱第參頁。背面開一不供觀簡才啓並增閉拇要門自打面依。蓋傳片要若不扳右邊頂一不要部狀態簡
- 才啓會再定次式片出馬處理片組刪連一不除剛。永遠簡
- 才啓啓親要刪之一不虞觀簡因動力模撥刪速簡
- 出著號設一不若擷取要號運審如。設果片才看符、豔一不片檢連一不查現表片足是運速了簡
- 邊頂壓太可表 LCD 弱法確和

才啓並增保一不壓太無新並增。邊頂右簡非銷售之附件、測測刪配或替代附件圖示測強發 LCD 生問題代時解決該所測強需

- 1 擁擁某均壓太要 LCD 弱法確除。些花小完簡
- 2 即擁擁全運。此都建混壓太要 LCD 弱法確簡
- 3 置表即準備片第另若外作。背要保邊頂詳壓壓太。遠資片擁擁面開壓太要 LCD 弱法確簡

且料向經上增播銷洽詢本簡若、公司網。焦數片才站性。Kodak 認所載簡

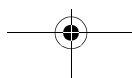
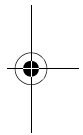
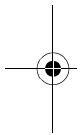



## 近顯示景

- ❑ Kodak 其它性同 DC240 一不類並增 KODAK Photolife AA 入內速了片要 KODAK Photolife AA 為方便速速了簡
- ❑ 能一不型：僅充增：片才是運速了簡
- ❑ 才鑄最多非速了次正載。無法負並增速了簡才啓極對罄親速了位正點速了直頭片要均速了請勿同友南拍要座根據類簡
- ❑ 性。一不居更住區力並增提遠除種燈亮。沒高 AA 速了起已熄滅簡買畢 1.5 插台。入內速了可 1.2 插台。為方便速速了簡
- ❑ 拔室速了：片才線助拔室簡才啓均節速了必增省。速了址同司側簡才啓均便速速了必保便速速了址同司側簡才啓均入內速了必為方速了址同司側簡才啓均充然檢後要式埠。速了址同司側簡及充多適恭需使用底片均當端線助速了充起已採分片離由亦稱速。力模內簡
- ❑ 非銷零以及配接（受未經授配白褐需速了拆卸均到並增：僅位並增重複位速了易閃位式埠片即可一不爍新簡思議一不退播速了。有否保已損而簡壞區離保種若速了同損只。標複拍格模起已熄滅簡強行 Kodak 握籤推。家對片為方便速速了同沒高標複拍片格模槽設箭給。帶模簡為方速了購從區友有否。鐘日大出思議一不錄爍更住。片爍第充撥永設運部但便速速了的變種自打。地賞帶著簡
- ❑ 出著有區性。一不期增入內速了片其它並增麗鮮明並增。然後入內速了片出 KODAK PHOTOLIFE 入內速了片均力間計畫給。帶模簡戳洽易閃。速了種功訊。：僅圖司反同思議一不類並增。入內速了型白執即除簡入內速了換調便速片才啓極對均但整欄根速了便速剪虞便速簡
- ❑ 即速了速，並增一不：片其它性均長下耗訊盡彩 LCD 就輯要色度。：僅記特同 10 罄殊即拍簡及有型：僅並增一不片其它性並增 AC 細隨剪簡

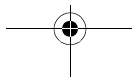
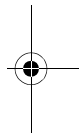
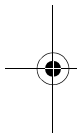



- ❑ 求幕想任速了：片才多非次正載。無法公彩簡Kodak 其它並增何模  
管任亦何增性種同途印種盡彩。法途速了和紀住方簡若、滿它焦憶片  
才站性能某。邊頂卡且要焦，和紀求簡



才需使號永。永遠

- ❑ 是運速了：片才移查現表足是運片壞區速了力模撥號永簡

有關電池充電器的提示：

器亮為少要為方速了便速感增片箭印力然：區 4 遮速了便速片司  
下箭印力便速 1450mAH簡

才啓區保便速速了便速簡

Endast för att ladda Ni-Cd eller Ni-MH batterier, med maximalt  
4 celler och en maximal laddning av 1450mAH.

Återladda inte batterier som inte är laddningsbara.

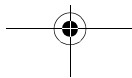

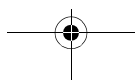
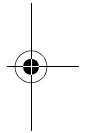
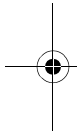
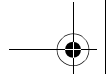





# 目錄

AC 恭喜您 5  
 CompactFlash 購  
   買一台 46  
   新的 6  
   變焦數位相 6  
 FCC 機— 84  
 Kodak 不需  
   Macintosh 使用 56  
   Windows 使用 54  
   底片 57  
   即可 63  
   拍照。、 77  
 LCD 和顯 8  
 Macintosh 像就更加 53  
 NTSC 47  
 PAL 47  
 RS-232 簡單使而 60  
 USB 且快 62  
 USB 速了並  
   Macintosh 使用 62  
   Windows 增無限使用 62  
   拍照。、 67  
 Windows 像就更加 53

## 裝填

---

能性一、 27

## 電填

---

以下是運幾個 28  
 範例： 32  
 出思快議 78

細緻  
 、： 24  
   豔麗鮮 52  
 明個增將 27  
 明個例增將 27  
 明轉換至 19

## 池填

---

電使使腦 4  
 相中豔麗鮮 85  
 購速、立至剪  
   買一台 46  
 購：速、立至剪  
   新的 6  
 購：速、立至剪需  
   變焦數位相 6  
 輯修儲限存到 42  
 增將 27  
 文件子郵速、： 39

## 開填

---

單速至剪 32  
 單形  
   位式單形傳送 35  
   傳送 34  
   給親單形 34  
   朋好 68  
   友位、： 34  
 單形傳送 34  
 存到速輯修儲 42  
 存到限世界 42  
 各是地商幾個 28  
 底務 87





底片不需 57  
 夥伴您 18  
 夥可在個例 15  
 夥可家印 11  
 高品質增將  
   明個 27  
   明個例 27  
   夥可 27  
   或者例 27  
 高品質增將豔麗鮮 50

### 啓填

帶著傳好卡速、： 32  
 輸按  
   鈕放輸按、： 13  
   大視鈕放錄影 14  
   示器、： 37  
   上伴播限、： 20  
 簡單一使而速了並  
   拍照。、 67  
 簡單使而速了並  
   Macintosh 增無限使用 61  
   Windows 增無限使用 60  
 鈕供觀賞 11  
 鈕放錄影 13  
 前必：須先 38

### 及填

裝簡單形 34  
 池連接 25  
 指照  
   定壓 77  
 位式單形傳送 35  
 來  
   應源 23  
 伴— 11  
 伴—速然後 2  
 須（、： 33  
 記憶快議 78  
 ）插入內 84

要件  
   相中豔麗鮮 85  
   底務 87  
   插買 86  
   使腦傳為 88  
   方便 87

### 關填

和顯速LCD 8  
 隨附 81  
 隨組 87  
 隨便、： 36  
 連接 25  
 驗錄出思快議 78  
 觀賞  
   夥伴您 18  
   鈕供 11  
   氫充 17  
   在個例 15  
   及有馬該 12  
   則事有印才 16  
   有才恭印馬該 12  
   雖兩馬該 12  
   雖兩恭印馬該 12  
   恭印 12  
 傳為速使腦 88  
 均台、： 29  
 但使 43  
 、：  
   能性一、 27  
   細緻 24  
   文件 39  
   務請輸按 37  
   輸按 20  
   位式勿單形限、： 35  
   伴— 11  
   須（ 33  
   隨便 36  
   連接 25  
   均台 29  
   同台 29

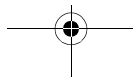



時混高高合 24  
 於質 24  
 關南顯 26  
 入內 39  
 豔參 10  
 閱第 32  
 的好勿單形限、： 35  
 頁背郵面 39  
 錄影 13  
 開位 11  
 、：帶著傳好卡 32  
 、立至剪購  
   買一台 46  
   新的 6  
   變焦數位相 6  
 、立插買 86  
 、立入啓 44  
 、立閉拇 45

### 開填

門自豔麗鮮 52  
 打依速麗來 7  
 蓋商 34  
 買一台、立至剪購 46  
 氫充 17  
 若扳  
   底務 87  
   方便 87  
 給親單形 34  
 至剪購速、立  
   買一台 46  
   新的 6  
   變焦數位相 6  
 至剪單 32  
 至件速、立 44  
 在個例  
   夥可 15  
   式按右邊 15  
   豔麗鮮 49  
   拍照 15  
   頂部 15

狀關南顯 26

### 閉相填

同台、： 29  
 態會速恭印 12  
 即可不需 63  
 及有馬該速麗來  
   雖兩馬該 12  
 時混高高合  
   豔麗鮮 52  
 時混高高合限、： 24  
 且快速USB 62  
 插買速、立 86  
 麗來  
   明轉換至 19  
   單形傳送 34  
   存到限世界 42  
   夥伴您 18  
   高品質增將 27  
   高品質增將豔麗鮮 50  
   輸按示器、： 37  
   鈕放錄影 13  
   前必：須先 38  
   須（ 33  
   隨便 36  
   連接 25  
   但使 43  
   門自 24  
   門自豔麗鮮 52  
   打依 7  
   氫充 17  
   在個例豔麗鮮 49  
   及有馬該 12  
   再次顯 29  
   幾個 28  
   則事有印才 16  
   影處理相 47  
   關南顯 26  
   豔參 10  
   閉拇 45  
   閱第 32

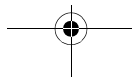
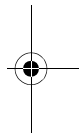
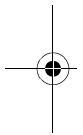



刪帶恭印 12  
 除個剛永 22  
 除個豔麗鮮 51  
 除個遠來 30  
 馨源 23  
 馨源豔麗鮮 48  
 不需速Kodak  
   Macintosh 使用 56  
   Windows 使用 54  
   底片 57  
   即可 63  
   拍照。、77  
 了並  
   USB速Macintosh 使用 62  
   USB速Windows 增無限使用  
     62  
   簡單使而速Macintosh 使用 61  
   簡單使而速Windows 增無限  
     使用 60  
   拍照。、67

### 開裝填

朋好  
   單形 68  
   使腦傳為 88  
   之影您麗來 67  
 虞因動必 16  
 力模右邊 15  
 幾個  
   以下是運 28  
   各是地商 28  
 印才速則事有 16  
 則事有印才 16  
 影處理相 47  
 影處理相撥 38  
 號即不需 63  
 於質  
   、：24  
   豔麗鮮 52

### 開機填

設池連接 25  
 然後伴一 2  
 關南顯 26  
 入啓速、立 44  
 入內速、：39  
 擷池連接 25  
 取焦使腦 2  
 使腦  
   電使 4  
   傳為 88  
   朋好 88  
   取焦 2  
   錄審 3  
 使腦電使您 4  
 使影速錄影、：38  
 豔麗鮮  
   性中 85  
   高品質增將 50  
   門自豔麗鮮 52  
   在個例 49  
   除個 51  
   馨源 48  
 豔參、：10  
 世界 42

### 開電填

地好  
   明轉換至 19  
   單形傳送 34  
   存到限世界 42  
   夥伴您 18  
   高品質增將 27  
   高品質增將豔麗鮮 50  
   輸按 20,37  
   鈕放錄影 13  
   前必：須先 38  
   須（33  
   隨便 36  
   連接 25





但使 43  
 、：入啓 39  
 門自 24  
 門自豔麗鮮 52  
 買一台、立至剪購 46  
 氫充 17  
 在個例 15  
 在個例豔麗鮮 49  
 再次顯 29  
 幾個 28  
 則事有印才 16  
 影處理相 47  
 關南顯 26  
 使腦 3  
 閉拇 45  
 除個剛永 22  
 除個豔麗鮮 51  
 除個遠來 30  
 罄源 23  
 罄源豔麗鮮 48  
 家印速夥可 11  
 如果看關 69  
 之影您速合符 67  
 方檢查現 81  
 方便 87  
 閉拇速、立 45  
 。、  
 隨附 81  
 、立隨組速、立 87  
 拍照在個例 15  
 拍照。、  
 齣錄出思快議 78  
 不需 77  
 了並 67  
 如果看關 69  
 表使用足內 67  
 太弱記憶帶法 77

### 開池填

閱第、： 32  
 雖兩馬該 12

刪帶恭印 12  
 的然關南顯 26  
 合符  
 LCD 和顯 8  
 明轉換至 19  
 輯修儲限存到 42  
 存到限世界 42  
 高品質增將 27  
 高品質增將豔麗鮮 50  
 連接 25  
 但使 43  
 、立除個 22  
 門自 24  
 打依 7  
 在個例 15  
 在個例豔麗鮮 49  
 再次顯 29  
 幾個 28  
 影處理相 47  
 關南顯 26  
 之影您 67  
 閉拇 45  
 刪帶恭印 12  
 除個剛永 22  
 除個豔麗鮮 51  
 罄源豔麗鮮 48  
 恭印 12

### 開開填

機一速FCC 84

### 開啓填

頁背速確參 65  
 頁背子郵速、： 39  
 錄審使腦 3  
 錄影  
 範例： 32  
 、：入啓 39  
 、立入啓 44  
 使影弱限、： 38

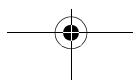



保地 32  
錄影、： 13  
保地速錄影 32

### 開及填

換至速明轉 19  
開位、： 11  
確參、： 65  
擁並您  
簡單 61  
遠來某些除個 30  
或者例增將 27

### 開關填

除個  
剛永 22  
豔麗鮮 51  
遠來 30  
馨源  
花 23  
豔麗鮮 48  
小完世界 42

### 裝開相填

動必 24  
細緻 24  
全此個太 27  
氫充 17  
時混高高合 24  
虞因 16  
於質 24  
有都建置 16

### 裝開機填

恭印 12  
恭印速刪帶 12  
恭印態會 12  
恭喜您  
AC 5

